



Do you have allergies?
Is the air in your office or home clean?



GO SHOPPING

SEARCH:

Friday, Mar

Products

- PestContro
- Home Fragrance
- Security
- Pet Products
- Sila Air Purifiers
- Accessories
- Pre-Releases
- Top 10 Products
- Web Only Specials
- Show All Products



8³⁰am-5³⁰pm EST

Monday-Friday

Customer Support

Company Information

- Lentek Home
- About Lentek
- News & Events
- Press Releases
- Become A Lentek Dealer
- Contacts at Lentek
- Jobs @ Lentek

Site Features

- Subscribe!
- Tell A Friend
- E-Letter Archive
- Post Your Pet Pictures!
- Site Map
- Premier Partners
- Lentek Links
- Be A New Product Tester
- Submit New Product Ideas
- For The Trade
- Lentek Gopher Bash

Sila Air Purifiers

People are now able to breathe clean and safe indoor air with our new **Sila™ Ai Purifiers/Cleaners**. This innovative line of air purifiers neutralizes unpleasant or airborne pollutants, and brings a breath of clean "mountain-fresh" air into the ho workplace using the natural processes that Nature uses to clean outdoor air. Le "Zyonic Technology™" energizes stale indoor air and cleans it with a Super-Oxic sanitizing process called ionization.

Indoor Air Problems

According to the EPA, indoor air pollution is our nation's biggest pollution proble here to learn about Indoor Air Problems.

Recommended Reading



The Allergy and Asthma Web Ring

This Allergy and Asthma Web Ring site owned by Lentek

[[Previous 5 Sites](#) | [Skip Previous](#) | [Previous](#) | [Next](#) | [Skip Next](#) | [Next 5 Sites](#) | [Random Site](#) | [List Sites](#)]

Submit your Allergy & Asthma Page to the Ring

[[Go Shopping](#) | [Customer Support](#) | [Site Map](#) | [F.A.Q.](#) | [Questions & Support](#)]

Send the Webmaster your comments!

PRODUCTS



© 2001 Lentek International, Inc.
Orlando, FL - (888) 3LENTEK
[Privacy Policy](#)



[This Site Best Viewed With IE 5+](#)



Do you have allergies?
Is the air in your office or home clean?



GO SHOPPING

SEARCH: **GO!**

Friday, Mar

- Products**
- PestContro**
 - Home Fragrance**
 - Security**
 - Pet Products**
 - Sila Air Purifiers**
 - Accessories**
 - Pre-Releases**
 - Top 10 Products**
 - Web Only Specials**
 - Show All Products**

8³⁰am-5³⁰pm EST

Monday-Friday

Customer Support

- Company Information**
- Lentek Home**
 - About Lentek**
 - News & Events**
 - Press Releases**
 - Become A Lentek Dealer**
 - Contacts at Lentek**
 - Jobs @ Lentek**

- Site Features**
- Subscribe!**
 - Tell A Friend**
 - E-Letter Archive**
 - Post Your Pet Pictures!**
 - Site Map**
 - Premier Partners**
 - Lentek Links**
 - Be A New Product Tester**
 - Submit New Product Ideas For The Trade**
 - Lentek Gopher Bash**

REGISTER

Sila Air Purifiers

14 product(s) in this category

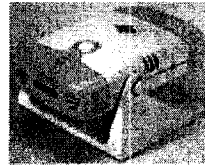

Sila Personal Pollution System
Personal Purifier monitors and controls air around you.

\$69.95



Compact Air Purifier
Dual function direct in compact air purifier deodorizer.

\$29.95



Auto Air Purifier
Freshen the air in your car! Plug into your cigarette lighter for fresh, clean air.

\$19.95

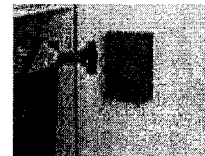

Trash Can Air Deodorizer
Remove trash can electronically!

\$19.95

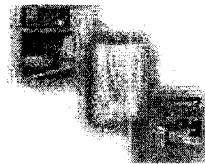

Refrigerator Deodorizer
The electronic baking soda. Wipe out fridge odors!

\$19.95

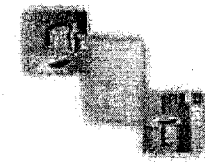

Hamper/Diaper Deodorizer
Remove hamper & diaper bin odors electronically. Incredibly effective product!

\$19.95



Closet and Travel Air Cleaner
Your electronic dry cleaner!

\$29.95

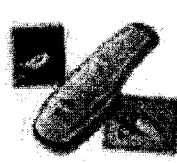

Clothes Freshener Lint Brush
Brush away odors removing lint!

\$19.95



Fresh Air
Improve the air you breathe indoors with Fresh Air.

\$29.95



Clean Air
Remove odors in problem areas.

\$29.95

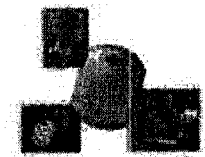

Personal Air Source Cream
Purify the air you breathe. The personal air purifier you wear! Feel better. Color: cream.

\$29.95

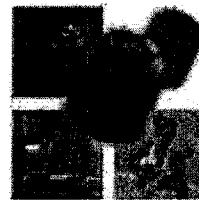

Personal Air Source Black
Purify the air you breathe. The personal air purifier you wear! Color: black.

PRODUCTS



\$29.95

Pet Brush & Flea Repeller
Brush odors away.
Give your pet a waterless bath.
Repels fleas too!

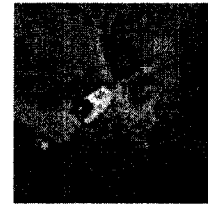

Small Pet Brush
Small pet brush th
removes odors. Gi
pet a bath without
Great for smaller p

\$29.95

\$34.95

14 product(s) in this category.

Sila Air Purifiers

Show Other Products

[[Go Shopping](#) | [Customer Support](#) | [Site Map](#) | [F.A.Q.](#) | [Questions & Support](#)]

Send the Webmaster your comments!

© 2001 Lentek International, Inc.
Orlando, FL - (888) 3LENTEK
[Privacy Policy](#)



This Site Best Viewed With IE 5+



I have to go.....



Pest Control	Home Fragrance
Pet Products	Air Purification
Comfort Air Cushions	Personal Care
Flashlights	More...

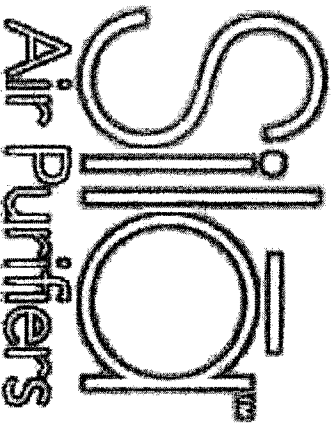

[Click logo to view products](#)

Create "Mountain Fresh" air with the use of Lentek's Zyonic Technology™! **Sila™ Air Purifiers and Deodorizers** recreate the natural process that nature uses to combat air pollution by generating low levels of super oxygenated air (O₃) and ionization - at prices everyone will love!

[Send the Webmaster your comments!](#)

© 2001 Lentek International, Inc.
 Orlando, FL - (888) 3LENTTEK
[Privacy Policy](#)

 This Site Best Viewed With IE 5+

- [Indoor Air Problems](#)
- [Recommended Reading](#)
- [Allergy & Asthma Webring](#)
- [SHOP NOW](#)
- [Pre-Release Products](#)
- [Our Best Sellers](#)
- [Today's Web Specials](#)
- [Customer Service](#)
- [Register Your Products](#)
- [About Lentek](#)
- [Site Features](#)
- [Search](#)
- [Home](#)

Dear Customer,
 Thank you and congratulations on your purchase of this ingenious device. This Slic™ product is the latest in new technology from Lenitek™. We are proud of the commitment to you, our customer, and healthier environment with a one (1) year warranty. Your satisfaction is very important to us.
 Visit our website at: www.lenitek.com and view the rest of our Slic™ products, or our PestControl™ products. While you're there, register your new purchase, sign up to receive our newsletter, and learn more about our company.
 Questions can also be asked on our website, or you can call: 1-888-353-6833, or 407-857-8786 or contact your local Lenitek dealer.
 We look forward to serving you, now and in the future.
 Enjoy the fresh air!

Joe Durak
 President

Lou Lentine
 Vice President

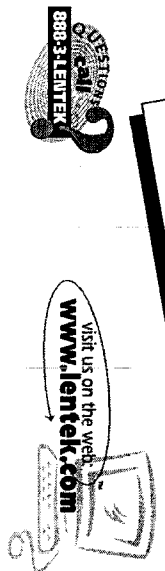

Why should you be concerned about the quality of the air you're breathing?
 Many people are aware of the damage that outdoor air pollution can cause to your health. What they may not know is that indoor air pollution exists and can have a significant effect on their health also. According to EPA studies, carbon levels of air pollution indoors may be 2-5 times higher than outdoors, and on occasion more than 100 times higher. Now, all of these pollutants could be contributing to those frequent unexplained headaches or the sleepless nights.

What can the Slic IO-31 do to help eliminate indoor air pollution?
 By introducing negative ions, using Lenitek's Zyonik™ Air Energizing Technology, to pollutants, such as dust, smoke, soot and pollen, the combined molecules drop to the ground, significantly reducing the number of airborne pollutants.

Lenitek has developed "Zyonik Technology"™ to help breakdown the impurities in the air. It helps to destroy pollen, flying dust, mold, mildew, fungi, bacteria and more. For allergy and hay-fever sufferers this is great news. In addition, the "Zyonik™ Super Oxidizing Sanitizing Technology" (SOS) will also help clean the air of odors. This makes the IO-30 ideal for use in the:

- Bathroom
- Kitchen
- Laundry Room
- Garbage Area
- Basements
- At Home
- In Public Restrooms
- In The Office
- Sporting Events
- In The Car
- Restaurants
- At The Gym
- In Public Places
- For City Dwellers
- In Hotel Rooms
- On Planes/Subways/Buses
- Anywhere...

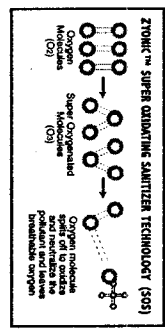
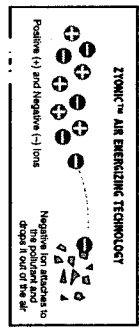

© 1999 Lenitek International. All rights reserved.
 All specifications are subject to change without notice.

IO-31 INST

My Air™
 PERSONAL
 AIR SOURCE

instruction
 guide

IO-31

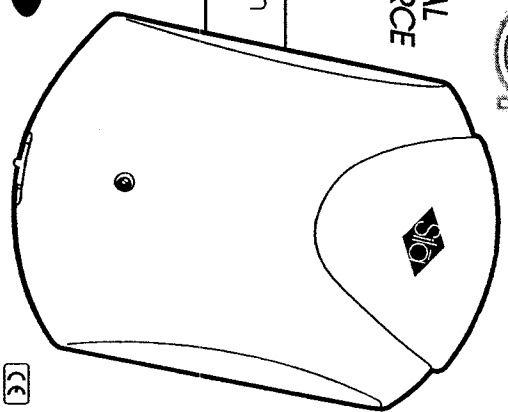

FUNCTIONS

GETTING STARTED

GREAT USES

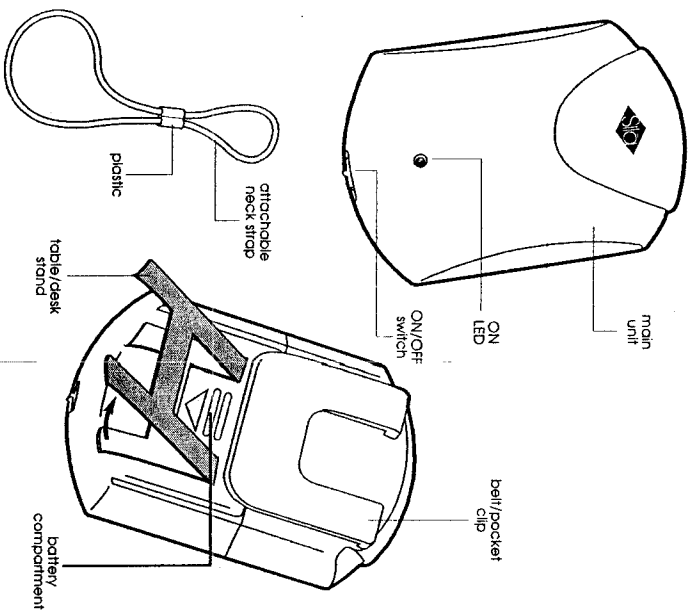

LOADING THE BATTERY:

This unit requires one (1) 9 volt battery (not included). Locate the ON/OFF switch. Make sure the unit is set to 'OFF'. The battery compartment is on the back of the unit. Simply push down slightly on the lid, then pull it toward you (see illustration A). Connect the battery to the receptacle. Slide and snap the lid back into place.

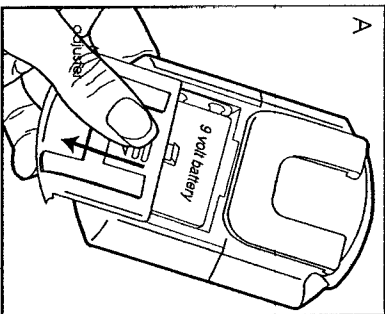

READY TO GO:

Locate the ON/OFF switch on the bottom of the unit and switch it to 'ON.' If the battery is loaded properly, the red LED on the front of the unit should go ON.

Your IO-31 includes a belt/pocket clip, a table/desk stand, and an attachable neck rope. Decide which of these will work best for you.

Enjoy the fresh air!

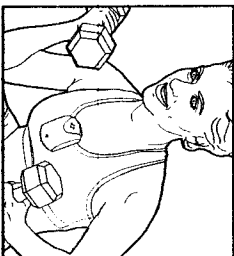

Help remove the body odor smells at the gym.

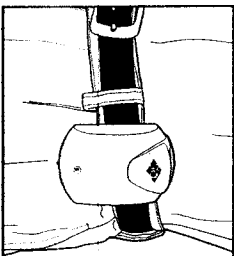

Help remove the germs & bacteria in public places.

Help remove second-hand cigarette smoke.

HERE ARE A FEW MORE GREAT USES:

On an Airplane or Any Public Transportation
In Smokey Bars, Clubs or Restaurants
At your Workplace
Hotel Rooms
just about any area with stale air!

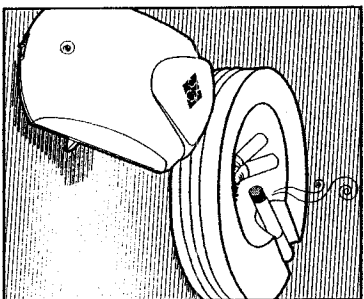

*Sweet Deals
for your Sweetheart*



At Lentek, we strive to make our customers lives easier.

Chat with a Live Customer Service Representative!



8³⁰am-5³⁰pm EST * Monday-Friday

Use code: **EPF101** to get free shipping on any order.

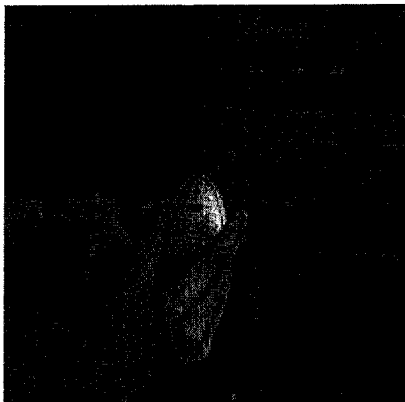

Plug in your **Auto Air Purifier** to any standard cigarette lighter to produce a cleaner, healthier driving environment. As you know, airborne toxins are present everywhere, especially in the car when it is concentrated in a small area. The Auto Air Purifier uses Lentek's exclusive Zyonic Technology™ to neutralize pollen, dust, smog, exhaust, fumes and other outdoor pollutants from your car's environment.

Zyonic Technology™ electronically oxidates the air sending the odor-neutralizing technology through the air ducts to remove the pollutants from your driving environment. This will help keep you alert while driving.

\$19.95 Order Online!

Exhibit E

Simply place the **Inscentable** unit in a central area of the house, insert a cartridge, plug the unit in, and enjoy the delightful aroma! Fragrance cartridges come in four wonderful scents: **Vanilla Supreme, Touch of Spice, Simply Cinnamon, and Citrus Breeze**. Holiday scents include **Winter Pine** and **Apple Cider** - get them while they last! One cartridge can last over a month when using it 2-3

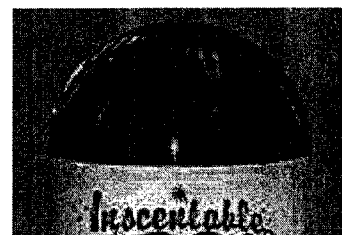

hours a day.

There are no open oils or waxes to spill, it doesn't tie up outlets in every room, there is no smoke or soot and it is not a fire hazard like candles.

Quantities of this new product are limited. Act now for the Holidays!

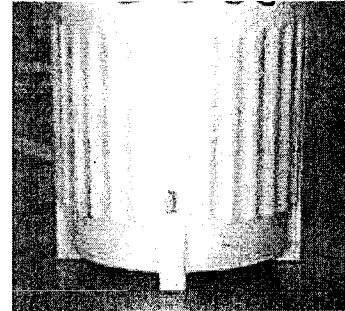

\$54.95 Order Online!

Just five minutes a day will help keep pet odors away and your pet feeling invigorated. Sila™ **Ionic Pet Massage** neutralizes pet odors using Lentek's exclusive **Zyonic Technology™** and helps loosen tangles and pet dander while gently massaging your pet. This is ideal for water-hating cats and long-haired dogs.

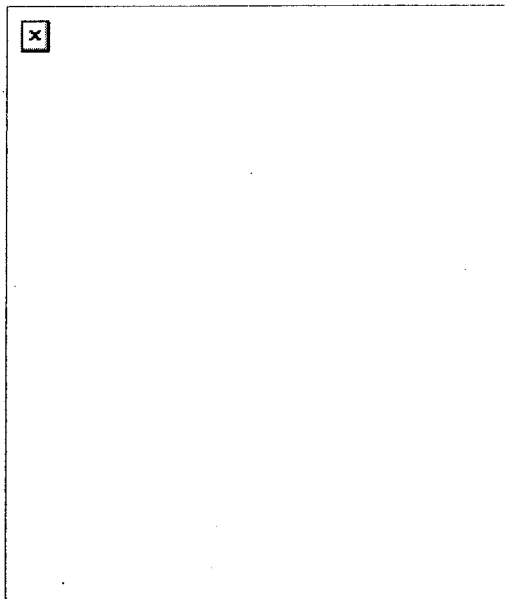

Zyonic Technology™ electronically oxidates the air sending the odor-neutralizing technology through the air ducts, leaving the pet smelling fresh and clean. This technology breaks down the impurities in the air helping to destroy pollen, flying dust, mold, mildew, fungi, bacteria, pet dander and more. The over 100 firm and short bristles allow you to comb away dander, tangles, and debris, conditioning the luster back into the pet's coat and massaging him. The massaging bristles are important in reducing stress and increasing blood circulation.

Your pet will love to be brushed and massaged and you will love to smell the results. Simple to clean too! Just lift off the brush plate and rinse under clean water. It's that easy!

\$39.95 Order Online!

If you cannot view HTML email, please visit

<http://www.lentek.com/archive/eletterfiles/feb01.html>

You received this email because you visited our website and registered to receive our newsletter and other special offers. If you do not wish to receive these special offers any longer, please send an email with your address asking to be removed to eletter@lentek.com.
Copyright © 2000 Lentek International, All Rights Reserved.

GO SHOPPING

SEARCH:

Wednesday, October 10, 2001

Sila Air Purifiers

IO11- Clean Air - \$19.99

- Pest Control
- Biogianta
- Pet Products
- Air Purification
- Comfort Air Cushions
- Personal Care
- Flashlights
- More...

Pre-Releases
Our Best Sellers
Today's Web Specials
Outlet Center

Customer Support
Site Features

- ★ Lentek Home
- ★ About Lentek
- ★ News & Events
- ★ Press Releases
- ★ Become A Lentek Dealer
- ★ Contacts at Lentek
- ★ Jobs @ Lentek
- ★ Search

REGISTER
PARTNER

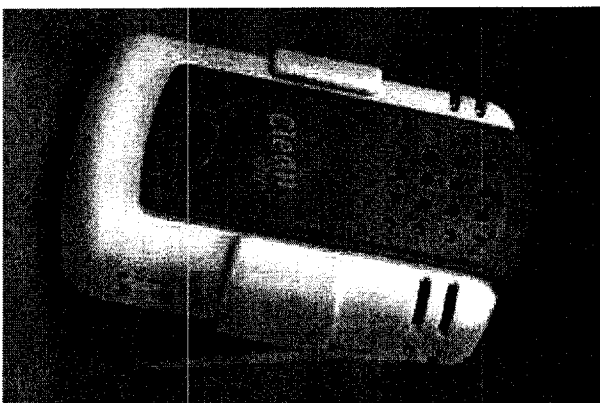

Sila™ Clean Air uses Zyonic Technology™ to improve the air you breathe!

Indoor air pollution, according to the EPA, is the biggest pollution problem in the United States today. The average person spends 90% of his or her time indoors, where pollutants such as bacteria and dust remain trapped. You are much more likely to get sick from the air you breathe indoors than outdoors. How can you fight indoor air pollution and improve the air you breathe? With Sila™ by Lentek.





This effective Zyonic Technology is contained in a compact, portable, and economical device. Remove Odors using Super Oxidating Sanitizer (SOS) technology actually refreshes oxygen molecules in the air. Great for kitchens, litter box area, or anywhere odor may hide. The Sila Clean Air fights these indoor pollutants: bacteria, mold, mildew, dust, pet dander, fungus, dust mites, dead skin flakes, chemical odors, pet odors, human odors, and more. Ideal for people with allergies, hay fever, unexplained headaches, and fatigue. Plug into any 110 volt outlet using the included DC Adapter. Operates discreetly and silently, with no moving parts to break or filters to change.



Features:

- Sturdy stand and attachment clip for quick mounting
- ON/OFF switch
- Red LED power indicator
- BOOST mode for extra cleansing power
- Powered by 9v 300mA DC Adapter (Included)
- Uses pennies of electricity per day
- Attractive and compact design
- Measures just 4" x 2" x 1"
- One year manufacturer warranty

Try Clean Air from Sila by Lentek today!

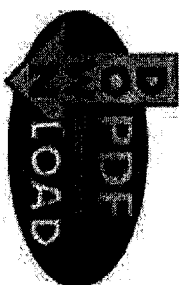

[E-mail A Friend](#)



Send the Webmaster your comments!

© 2001 Lentek International, Inc.
Orlando, FL - (888) 3LENTTEK
[Privacy Policy](#)

This Site Best Viewed With:





GO SHOPPING

Multiple uses!

SEARCH:

Wednesday, October 10, 2001

Sila Air Purifiers

IO30- Sila Personal Pollution System - \$69.99

Exhibit G

- Pest Control
- Blagierite
- Pet Products
- Air Purification
- Comfort Air Cushions
- Personal Care
- Flashlights
- More..

Pre-Releases
Our Best Sellers
Today's Web Specials
Outlet Center

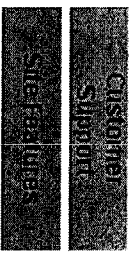

- ★ Lentek Home
- ★ About Lentek
- ★ News & Events
- ★ Press Releases
- ★ Become A Lentek Dealer
- ★ Contacts at Lentek
- ★ Jobs @ Lentek
- ★ Search

REGISTER DEALERS

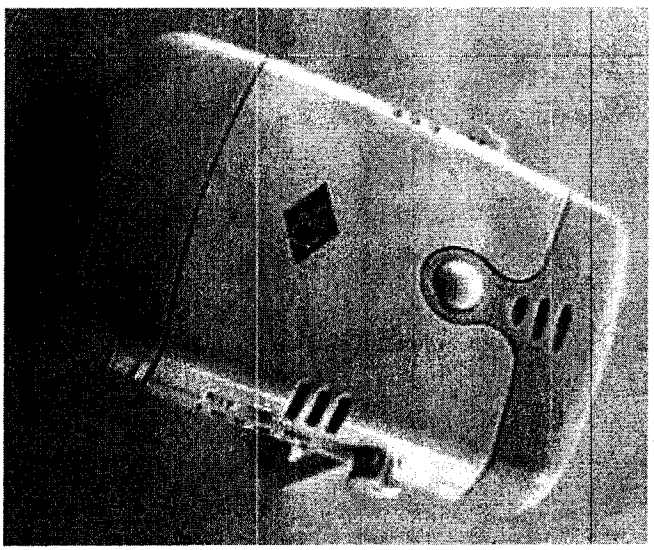

Lentek's new My Air™ Personal Purifier with Pollution Sensor monitors and controls the air quality around you while keeping you energized and stress-free by neutralizing airborne pollutants. Lentek's Zyonic Technology produces ions to clean and neutralize odors in the air you breathe.

Utilizing the same technology as is used in casinos, malls and airports, the Personal Purifier cleans the air using the same technology. The quality of air is continually monitored and tested to ensure the concentration levels of carbon monoxide are kept low.

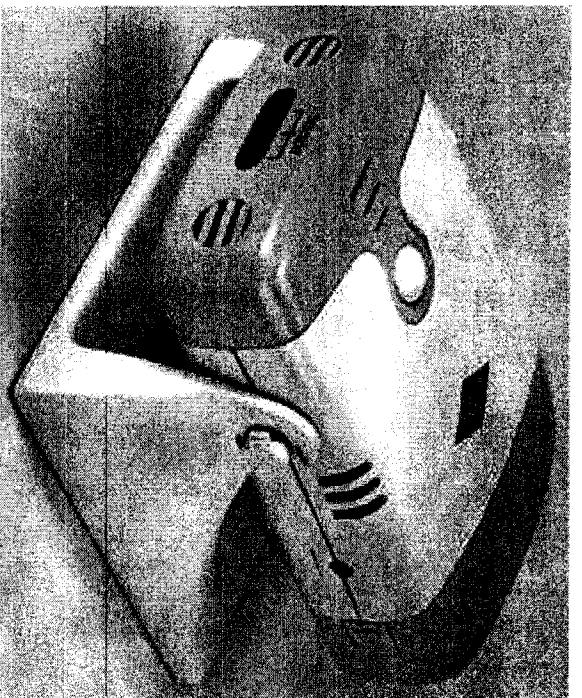

There are 3 settings to be used: Purify On, Quality Indicator and Vehicle Setting. The vehicle setting can only be used to purify air when the car is in motion. The LED quality indicator monitors pollutants with three air quality indicators: GOOD/ FAIR/ BAD

Ideal for:

- Allergies
- Areas with stale air
- Hay fever sufferers
- At home
- Business travellers
- At work
- Hotel rooms
- City dwellers
- Long road trips

Features:

- Helps relieve depression, lethargy and stress caused by stale air.
- Tests and monitors air quality.
- Long battery life - over 30 hours from a single 9-volt battery
- No filters to change or replace
- Small, discreet and lightweight
- Can be clipped on clothes, belts, worn around the neck, placed on flat surfaces or mounted in a vehicle
- Includes: table stand, belt clip, automotive dash mount and adjustable neck strap

For more uses, click [here](#)

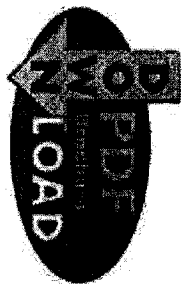

[E-mail A Friend](#)



[Send the Webmaster your comments!](#)

© 2001 Lentek International, Inc.
Orlando, FL - (888) 3LENTEK
[Privacy Policy](#)

This Site Best Viewed With:





Multiple uses!



GO SHOPPING

SEARCH:

Wednesday, October 10, 2001

Pest Control

Blagianta

Pet Products

Air Purification

Comfort Air Cushions

Personal Care

Flashlights

More...

Pre-Releases
Our Best Sellers
Today's Web Specials
Outlet Center

Customer Support

Sitemap

- ★ [LenTek Home](#)
- ★ [About LenTek](#)
- ★ [News & Events](#)
- ★ [Press Releases](#)
- ★ [Become A LenTek Dealer](#)
- ★ [Contacts at LenTek](#)
- ★ [Jobs @ LenTek](#)
- ★ [Search](#)

REGISTER

IO12- Fresh Air - \$19.99

Sila Air Purifiers

Add to cart

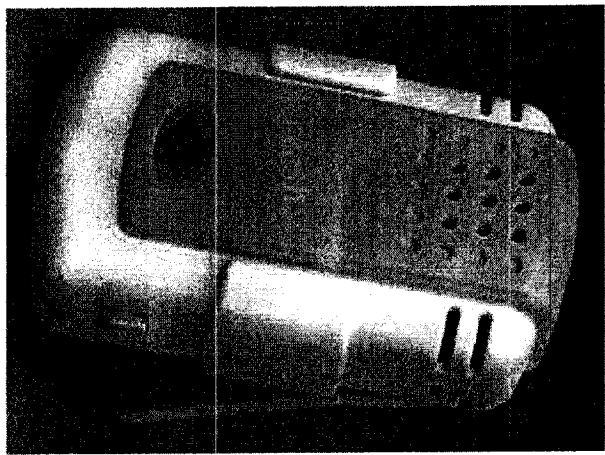

Sila™ Fresh Air by LenTek uses Zyonic Technology™ to improve the air you breathe! Indoor air pollution, according to the EPA, is the biggest pollution problem in the United States today. The average person spends 90% of his or her time indoors, where pollutants such as bacteria and dust remain trapped. You are much more likely to get sick from the air you breathe indoors than outdoors. How can you fight indoor air pollution and improve the air you breathe? With Sila™ by LenTek.





This effective Zyonic Technology is contained in a compact, portable, and economical device. The Sila Fresh Air purifies and cleans the air with trillions of negative ions. The negative ions attach to airborne pollutants such as dust, smoke, soot and pollen, dropping them to the ground. This significantly reduces the pollutants in the air, cleaning the air you breathe. Perfect for anywhere in the home. Plug into any 110 volt outlet using the included DC Adapter. Operates discreetly and silently, with no moving parts to break or filters to change. Set in on the night stand, counter, coffee table or clip it to your headboard for better nighttime sleep quality. Ideal for people with allergies, hay fever, unexplained headaches, and fatigue.

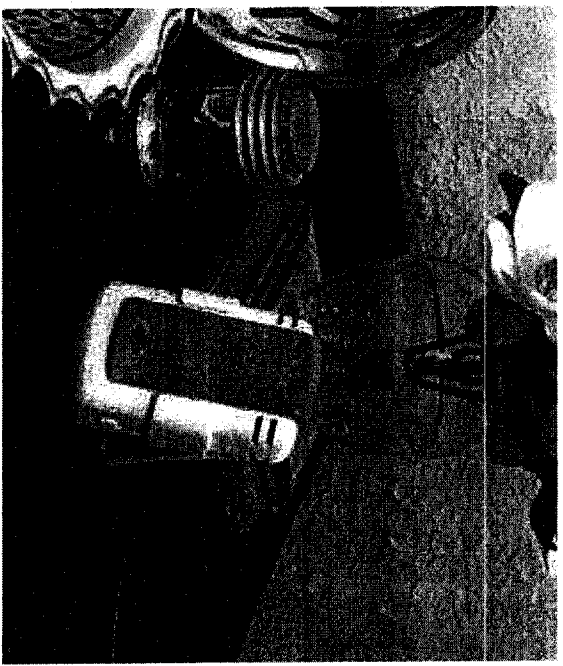

Features:

- Sturdy stand and attachment clip for quick mounting
- ON/OFF switch
- Red LED power indicator
- Powered by 9v 300mA DC adapter (included)
- Uses pennies of electricity per day
- Measures just 4" x 2" x 1"
- Attractive and compact design
- One year manufacturer warranty

Try Fresh Air from Sila by Lentek today!

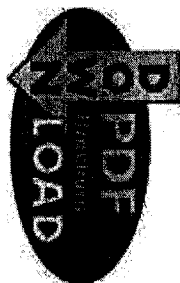

Back 

[E-mail A Friend](#)



[Send the Webmaster your comments!](#)

© 2001 Lentek International, Inc.
Orlando, FL - (888) 3LENTEK
[Privacy Policy](#)

This Site Best Viewed With:





GO SHOPPING

SEARCH:

Wednesday, October 10, 2001

TRY BARKFREE TODAY!!!



Exhibit I

- Pest Control
- Blagiante
- Pet Products
- Air Purification
- Comfort Air Cushions
- Personal Care
- Flashlights
- More...

Pre-Releases
Our Best Sellers
Today's Web Specials
Outlet Center

- Customer Support
- Site Features

- ★ Lentek Home
- ★ About Lentek
- ★ News & Events
- ★ Press Releases
- ★ Become A Lentek Dealer
- ★ Contacts at Lentek
- ★ Jobs @ Lentek
- ★ Search

REGISTER

IO35- My Air™ Mini Personal Air Purifier - \$59.99

ADD TO CART

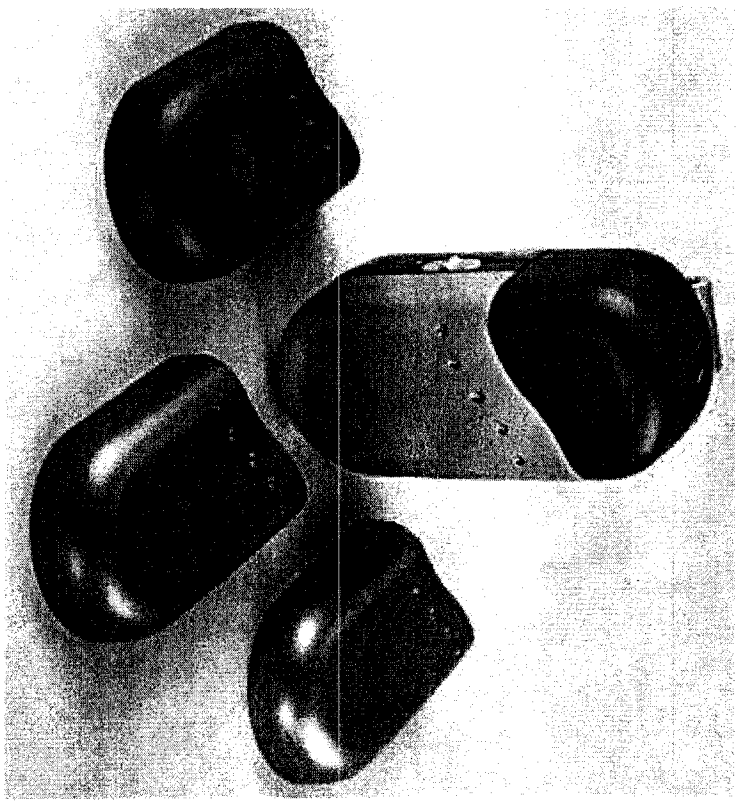

Clean and Neutralize Your Air
Allergies getting you down?
Tired of breathing in second-hand smoke?



Everywhere you go you are in danger of air pollution these days. But now you can take fresh air with you wherever you go. **"My Air"TM Mini Personal Air Purifier** keeps you energized and stress-free by cleaning and neutralizing airborne pollutants and odors. Lenetck's Zycronic Technology produces ions to clean and neutralize odors in the air you breathe.

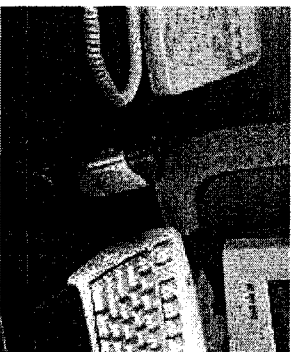

The Sila **"My Air"TM Mini Personal Air Purifier** is small - Only 3 inches long - discreet and lightweight. It comes with a neck strap or can be clipped onto clothes or a belt. It also comes with 3 additional snap-on covers in designer colors, to coordinate with everything you wear.



- Features:
- 4 Snap-on colored covers
 - Only 3 inches long
 - Silent operation
 - No dangerous chemicals

Rechargeable battery
Battery provides over 5 hours of continuous use before recharging
No filters to change or replace
Discreet and lightweight
Includes: adjustable neck strap, attachment clip for multi-purpose use and a quick charge plug-in battery charger

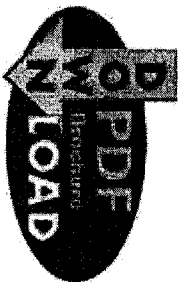

[E-mail A Friend](#)



[Send the Webmaster your comments!](#)

© 2001 Lentek International, Inc.
Orlando, FL - (888) 3LENTTEK
[Privacy Policy](#)

This Site Best Viewed With:





**PURE,
CLEAN AIR**

Exhibit J

LENTEK

Sila™ is named after the divine ruler of the Eskimo. Sila™ is the air that one breathes and the energy that moves all, the entire universe as well as each individual.

According to the EPA, indoor air pollution is our nation's biggest pollution problem. **Why?** Because, in our new and efficient structures we block out nature's cleaning agents and trap the pollution inside with us. Sila™ air purifiers and deodorizers use Zyonic™ Technology. This is Lentek's exclusive process that replicates indoors what Mother Nature provides outdoors. According to the EPA, certain levels of air pollution indoors may be 2-5 times higher than outdoors, and on occasion more than 100 times higher.

Now consider this...most people spend 90% of their time indoors. You are more likely to get sick from the air you are breathing indoors than outdoors. The indoor pollutants can also be contributing to frequent unexplained headaches and sleepless nights.

Possible indoor pollutants:

- | | | |
|------------------|------------|-------------------|
| Mildew | Mold | Aerosol sprays |
| Fungus | Dust | Air Fresheners |
| Dust Mites | Pet Dander | Cleaning Supplies |
| Dead Skin Flakes | Bacteria | Plastics |

PLUS MANY CHEMICALS!

Pollutants	Sources	Symptoms
BENZENE	Paint, new carpets, new drapes and upholstery	Headaches, eye/skin irritation, fatigue, cancer
AMMONIA	Tobacco smoke, cleaning supplies	Eye/skin irritation, headaches, nose-bleeds, sinus problems
CHLOROFORM	Paint, new drapes, upholstery, new carpeting	Headaches, asthma attacks, dizziness, eye/skin irritation
FORMALDEHYDE	Tobacco smoke, plywood, furniture, particle board, office dividers, new carpets, new drapes, wallpaper, paneling	Headaches, eye/skin irritation, drowsiness, fatigue, respiratory problems, memory loss, depression, gynecological problems, cancer
BENZOPYRENE	Tobacco smoke	Asthma attacks, eye/skin irritation, respiratory irritation
HYDROCARBONS	Tobacco smoke, gas burners, furnaces	Headaches, fatigue, nausea, dizziness, breathing difficulty
TRICHLOROETHYLENE	Paint, glues, furniture, wallpaper	Headaches, eye/skin irritation, respiratory irritation
XYLENE	Paint, new drapes, new carpets, cleaning supplies	Headaches, dizziness, fatigue

HOW DOES Sila™ HELP ELIMINATE INDOOR AIR POLLUTION?

Lentek has developed a process called "Zyonic™ Technology." This technology has two processes that occur simultaneously.

The first is called "Super Oxidating Sanitizer" (SOS). SOS restores freshness and neutralizes odors and pollutants by introducing super oxygenated molecules (O3). The SOS process takes oxygen (O2) and forces them into O3 molecules. The third oxygen molecule then splits off and neutralizes the odor or pollutant and leaves the other two oxygen molecules behind as fresh breathable O2.

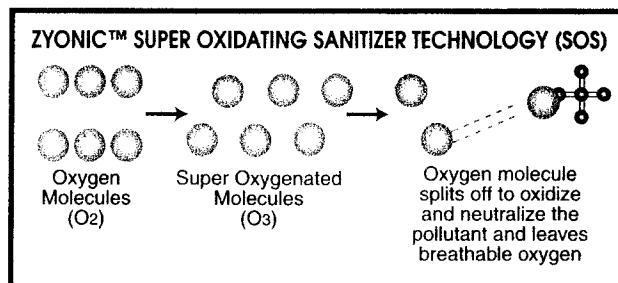

The second process is called Zyonic™ Air Energizing Technology. This process introduces negative ions to the pollutants, such as dust, smoke, soot and pollen. The combined molecules then drop to the ground, significantly reducing the number of airborne pollutants. For allergy and hayfever sufferers, this is ideal!

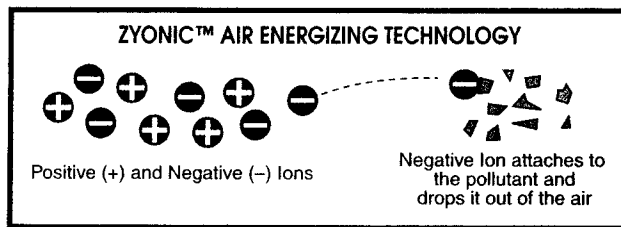

With the combination of these two processes, Zyonic™ Technology brings indoors, what Mother Nature creates outdoors!

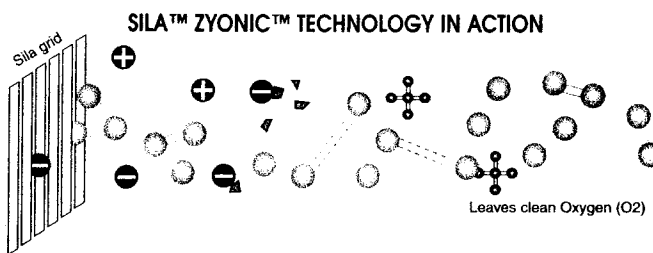

IO-10

Sila™ PLUG-IN AIR PURIFIER/DEODORIZER

All of the Sila™ products utilize Zyonle™ Technology, but the IO-10 takes it a step further. LenteK has devised a way to allow the user to target the particular air pollution problem that they are experiencing by placing a dial on the top of the device with two selectable settings. The "SOS" setting and the "SIR" setting.

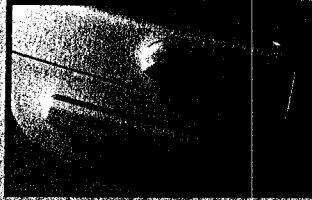

The "SOS" setting, which stands for Super Oxidizing Sanitizer, helps to neutralize odors into clean, fresh oxygen. This makes it ideal to use in the bathroom, kitchen, pet area and other places where odors linger.

The "SIR" setting, which stands for Super Ionic Release, creates an extra amount of negative ions, which can be used in any area of the home or office to help significantly reduce the amount of dust, smoke, pollen and other airborne pollutants that may exist. This makes this device ideal for allergy and hayfever sufferers. Negative ions have also been used to help decrease "office fatigue" and some forms of "depression".

IDEAL FOR USE:

- BATHROOMS
- KITCHENS
- BEDROOMS
- LIVING ROOMS
- OFFICES
- GAME ROOMS
- PET AREAS
- HOTEL ROOMS
- Anywhere!

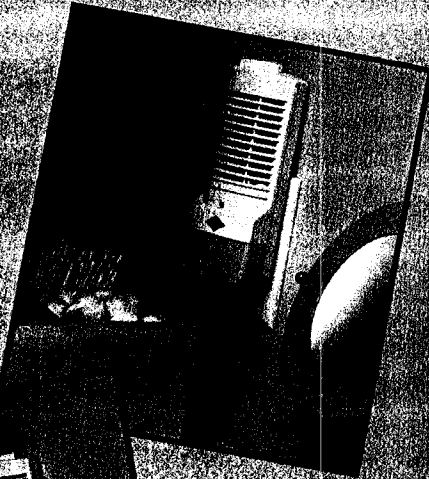

SELECTABLE
AIR PURIFICATION SETTINGS

INCLUDES
NIGHT LIGHT

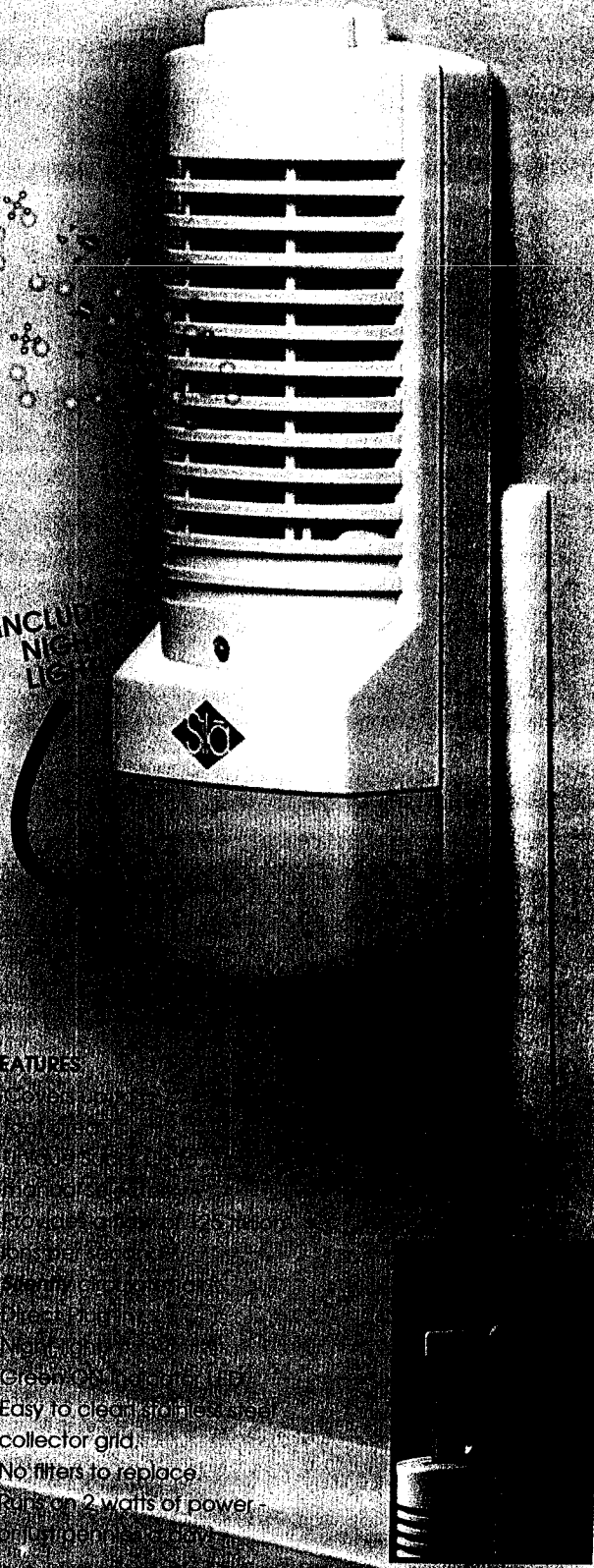

FEATURES

- Selectable "SOS" or "SIR" setting
- Night light
- Green LED indicator light
- Easy to clean stainless steel collector grid
- No filters to replace
- Runs on 2 watts of power
- On/Off/Standby buttons

IO-11*Includes Stand & Attachment clip for multipurpose use!***Sila™ Clean Air
PORTABLE COMPACT AIR PURIFIER****CLEAN**

Clean Air - Remove odors using Super Oxidating Sanitizer (SOS) technology - actually refreshes oxygen molecules in the air. Great for: •kitchens •litter box area •or anywhere odor may hide.

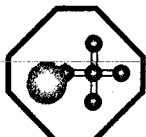
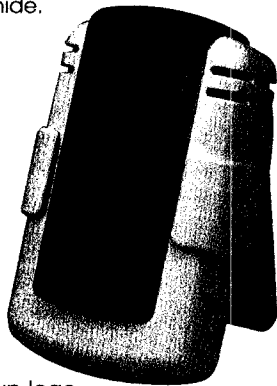
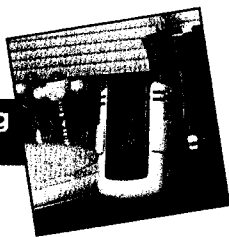
**AIR****Cleaning the Air**

- ON/OFF BOOST switch
- Red LED power indicator lights up logo
- Uses pennies of electricity per day
- Attractive and compact design
- Powered by an adapter (included)

IO-12*Includes Stand & Attachment clip for multipurpose use!***Sila™ Fresh Air
PORTABLE COMPACT AIR PURIFIER****FRESH**

Fresh Air - Purifies and cleans the air with trillions of negative ions. Helps reduce airborne pollutants such as dust, smoke, and bacteria. Perfect for anywhere in the home. Set it on the: •night stand •counter •coffee table •or clip it to your headboard for better sleep quality.

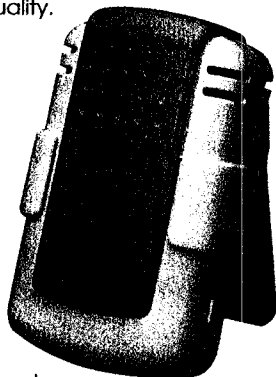
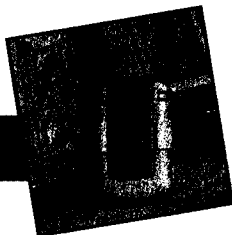
**AIR****Ionizing the Air**

- ON/OFF switch
- Red LED power indicator lights up logo
- Uses pennies of electricity per day
- Attractive and compact design
- Powered by an adapter (included)

IO-31**Sila™ My Air™
PERSONAL AIR SOURCE**

This device creates pure mountain fresh air in a compact, portable and discreet device. It's battery operated, on just one (1) 9 volt battery (not included), with over 30 hours of battery life. Not only does it have a built-in pocket/belt clip, but also has built-in legs which allows it to stand on a desk or table. Also included is an attachable, adjustable neck strap.

IDEAL FOR USE:

- Allergy and Hay Fever Sufferers
- Business Travelers
- In the Office
- City Dwellers
- On a Plane
- Hotel Rooms
- Anywhere with indoor air pollution!



*"Now"
available in
Black
(IO-31B)*

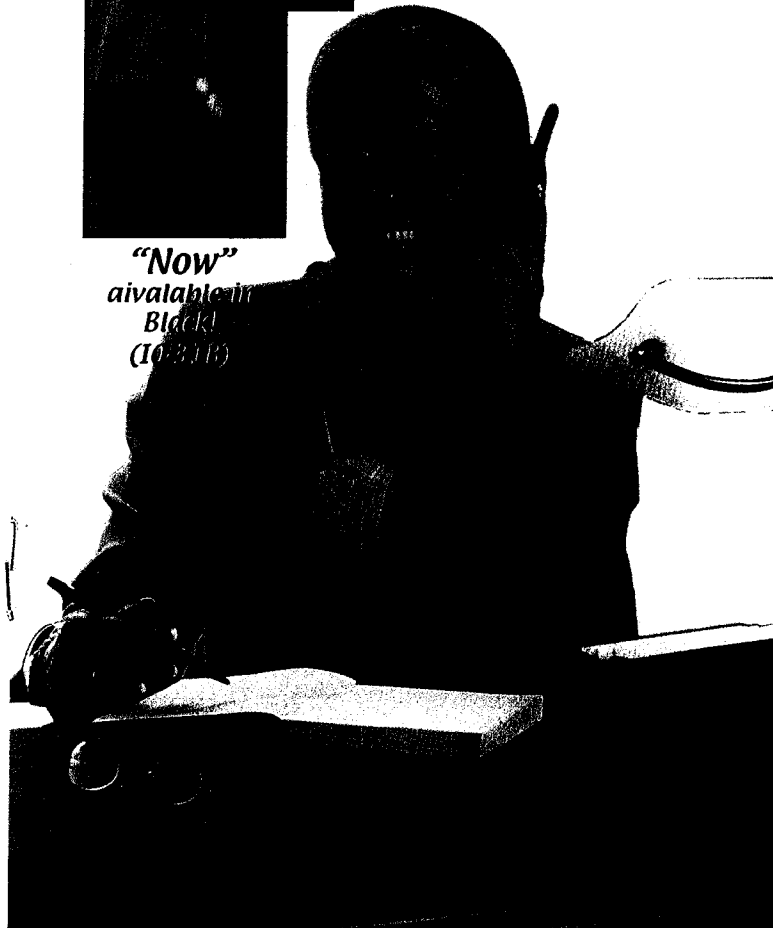

IO-20

Sila™ CLOSET & TRAVEL AIR PURIFIER/DEODORIZER



Disgusted by the smoke smell in your clothes after being in a restaurant or bar?

Can't stand the mildew smell in your closet?

Want to get one more wear out of your suit before paying for expensive dry cleaning?

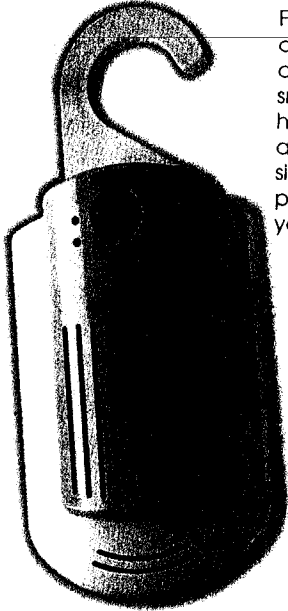

Fabrics in clothing trap all kinds of airborne particles - from bacteria and pollen to second-hand smoke and body odor. The IO-20 hangs on your closet rod, or sets in a gym or travel bag, working silently to help eliminate odors and pollutants and restore freshness to your garments.

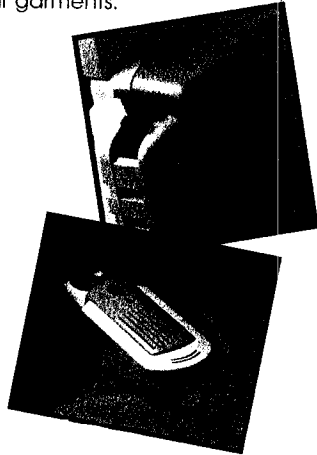

IO-40

Sila™ CLOTHES FRESHENER and LINT BRUSH

Clothing collects pollutants in the fabric. Even though a garment may look clean, it no longer has that "fresh from the cleaners" smell. Sweep away those unpleasant odors while removing lint and pet hair. Cut back on your dry cleaning bills. Get the cigarette smell out of your clothes. Zyonic™ Technology helps neutralize odors without wear and tear on your clothing.

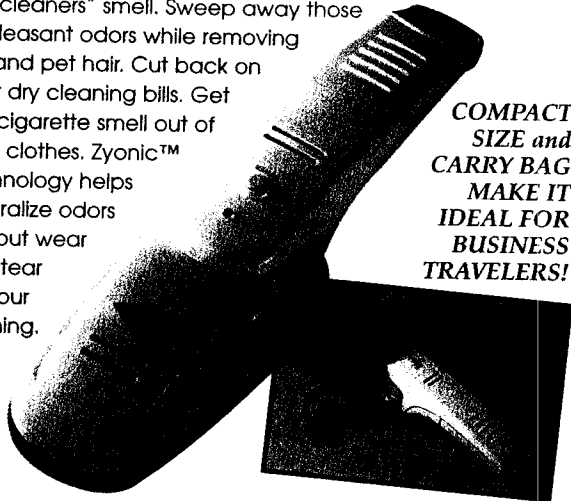

COMPACT SIZE and CARRY BAG MAKE IT IDEAL FOR BUSINESS TRAVELERS!

The sturdy bristles of the IO-50 and IO-55 will help you comb out most stubborn tangles, while Zyonic™ Technology gently and silently bathes your pet with up to 100 trillion super oxygenated molecules and negative ions every second. It breaks down the odors and particles that cause them and leaves only fresh oxygen in its path, so your pet ends up smelling fresh and looking clean.



IO-50

Sila™ WATERLESS BATH and FLEA REPEL BRUSH

Brush away unpleasant pet odors while repelling fleas! This brush utilizes Lentek's exclusive flea repelling technology. It emits ultrasonic waves set to a specific frequency targeted to repel fleas, but is completely harmless to your pet.



IO-55

Sila™ WATERLESS BATH BRUSH

This compact size brush is ideal for use with smaller pets.

Brush for Five (5) Minutes a Day And Help Keep Odors Away!

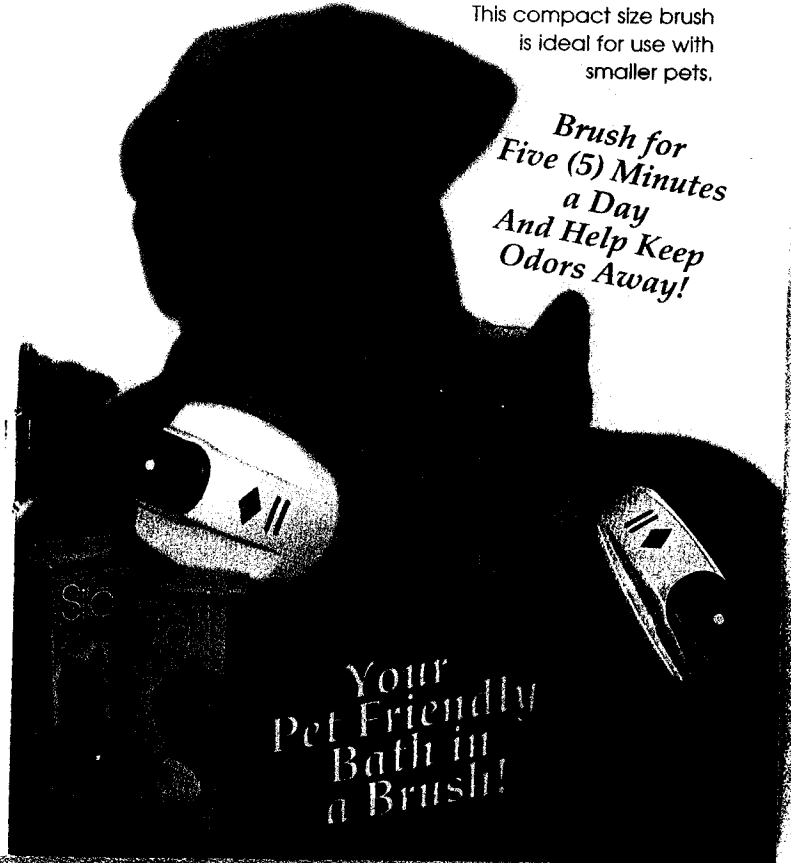

Your Pet Friendly Bath in a Brush!

IO-60

Sila™ AUTO AIR PURIFIER/DEODORIZER

Designed to fit in most cigarette lighter outlets, this device will freshen and deodorize the air in your vehicle using Zyonite™ Technology. The IO-60 will help in removing and neutralizing smog, exhaust, pollen, dust and bacteria, which are irritating and can cause fatigue.

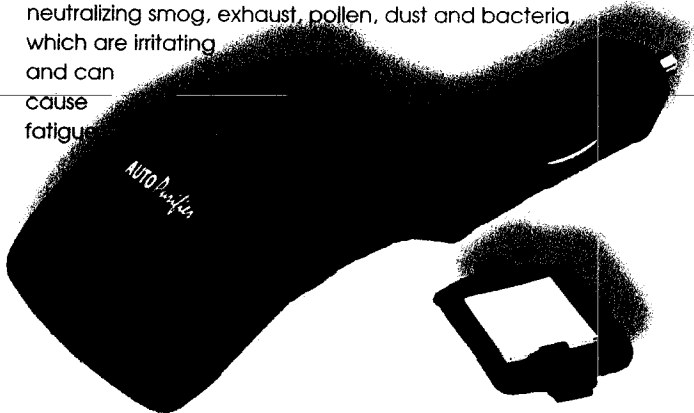

With its built-in pivoting arm, you can adjust it in whatever direction suits you best.

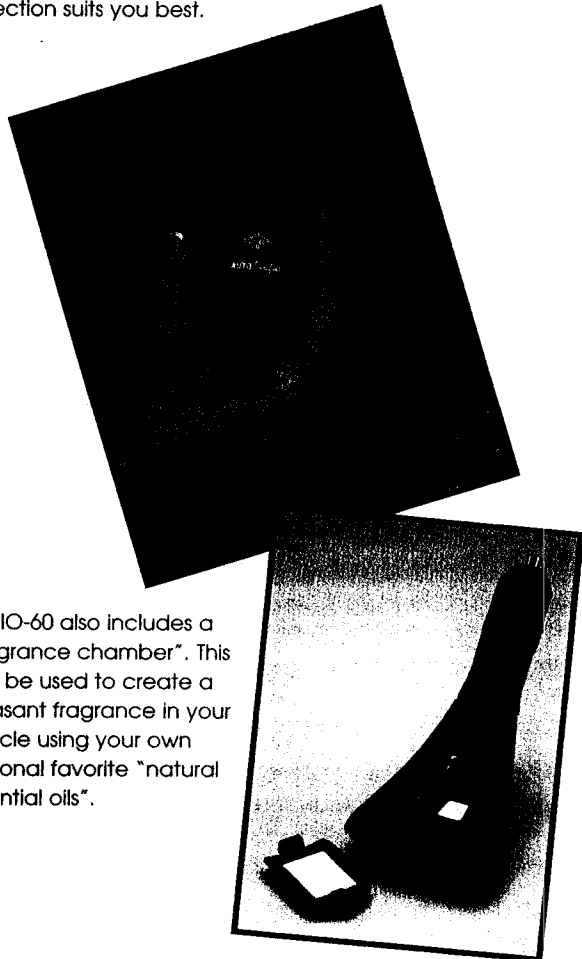

The IO-60 also includes a "fragrance chamber". This can be used to create a pleasant fragrance in your vehicle using your own personal favorite "natural essential oils".

Sila™ AIR PURIFIER/DEODORIZERS

These attractive and sturdy devices operate on just four (4) 'C' batteries which will last up to four (4) months. There are no filters to change, they work SILENTLY and have no moving parts. They all include two (2) different attachments for hanging. One attachment allows you to hook the device. The other easily attaches, with included material, to a nearby wall, or cabinet door.

IO-70 TRASH

Place this device near your trash, litter box, or anywhere that odors linger. Great for use near cat litter boxes!

IO-80 FRIDGE

This is the millennium's version of baking soda. Use it in the fridge, freezer or even your cooler to keep food smells from lingering and spreading to other food.

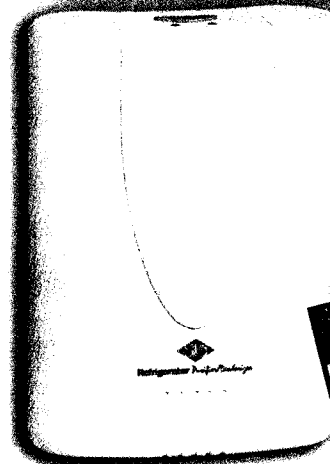

IO-90 HAMPER

Neutralize nasty odors and airborne pollutants in and around your laundry or diaper hamper and replace it with clean fresh air!

ALSO,
Great for
use in
Gym
Lockers!

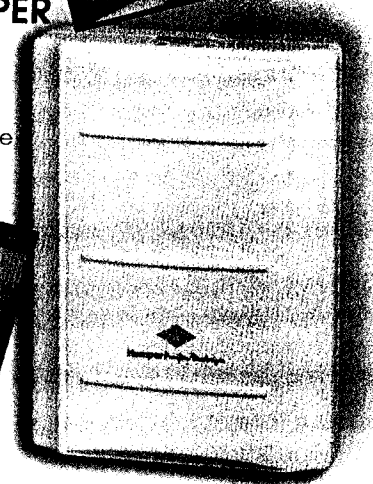
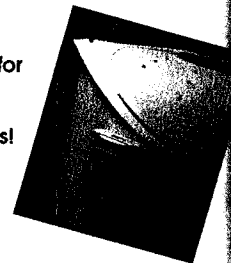

LENTEK

LENTEK INTERNATIONAL, INC.

PO Box 593812
Orlando, FL 32859-3812

Phone: 407 • 857 • 8786
Fax: 407 • 857 • 4045
Toll Free: 800 • 456 • 3443
E-Mail: customerservice@lentek.com



visit us on the web:
www.lentek.com

PRESORT STD
US POSTAGE
PAID
PERMIT #2599
ORLANDO, FL

AD00140
LITSILA1-0100

© 2000 Lentek International, Inc., All rights reserved.
All specifications are subject to change without notice.



Now you Know!

GO SHOPPING

SEARCH:

Wednesday, October 10, 2001

Indoor Pest Control Products

PR22- PestContro Ultrasonic Dual - \$29.99

- [Pest Control](#)
- [Blagiante](#)
- [Pet Products](#)
- [Air Purification](#)
- [Comfort Air Cushions](#)
- [Personal Care](#)
- [Flashlights](#)
- [More...](#)

Pre-Releases
Our Best Sellers
Today's Web Specials
Outlet Center

[Customer Support](#)

[Site Features](#)

- ★ [Lentek Home](#)
- ★ [About Lentek](#)
- ★ [News & Events](#)
- ★ [Press Releases](#)
- ★ [Become A Lentek Dealer](#)
- ★ [Contacts at Lentek](#)
- ★ [Jobs @ Lentek](#)
- ★ [Search](#)

[REGISTER](#)

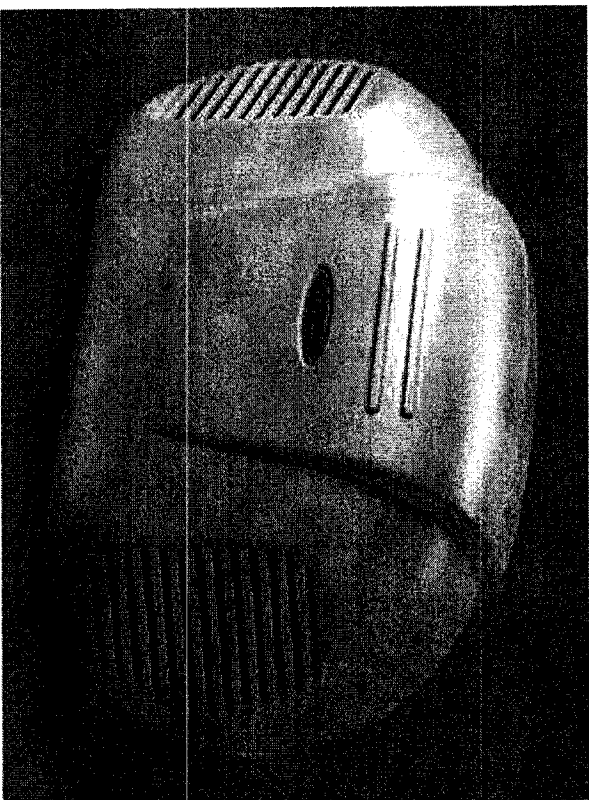

Advanced innovative indoor/outdoor tabletop design ultrasonic pest repeller technology covers up to 3000 square feet to repel pests but is completely inaudible to humans.

Dual transducers provide increased ultrasonic coverage for your home, including a BOOST mode for extra pest repelling power. The adjustable frequency helps you target your pest problem.

PestContro's innovative ultrasonic technology repels pests but is inaudible to humans. Adjustable design allows you to select frequency level to target your pest problem. One setting has higher frequencies to affect small insect pests, while the



second setting can be used for larger rodent pests.

Using "Sweep Sound Technology" (SST), the unit creates a fluctuating ultrasonic sound to target pests within these ranges. This creates a very uncomfortable environment for pests, driving them from their hiding places within your home.

Simply place the unit in a location of the room where the ultrasonic waves can be projected in a straight line. An effective ricochet pattern can be obtained by bouncing the waves off reflecting objects such as walls and wood furniture. Placing another unit on the opposite side of the room will increase the effective coverage.

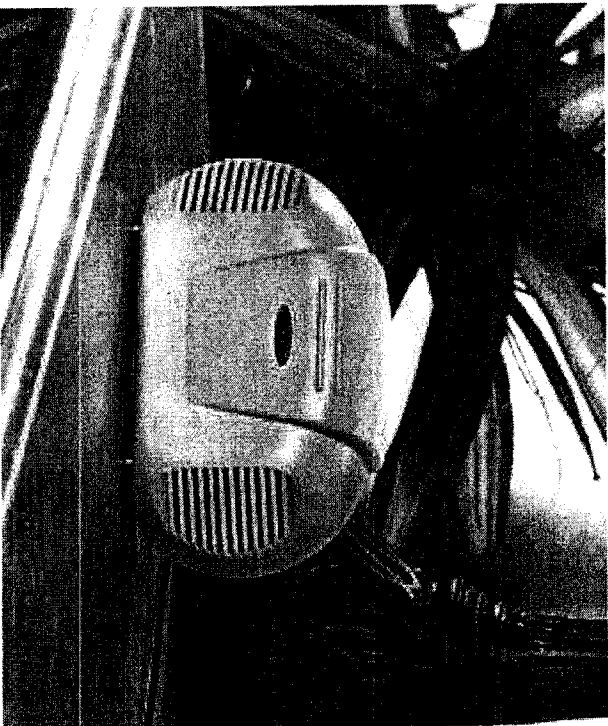

Repels Unwanted Insect and Rodents, such as: Rats, Mice, Ants, Roaches, Crickets, Squirrels, Bees, Spiders, Fleas
PestContro Ultrasonics Dual will not affect humans, pets (dogs, cats, birds, fish), computers or appliances.

The ultrasonic sounds may affect rodent pets such as hamsters, gerbils and rabbits. **However**, if you position the unit away from the rodent pets, it may not cause them discomfort.

Dual transducers provide increased ultrasonic coverage
Adjustable frequency helps you target your pest problem.
BOOST mode for extra pest repelling power
Compact portable design can be used in indoor our outdoors in a protected area.
Great for combining with PestContro Original for added protection.
Environmentally safe and economical pest control solution!

- Features:
- Compact, attractive design (145 x 85 x 52mm)
 - Powered by DC adapter (included)
 - Dual ultrasonic transducers
 - Switch OFF to stop operation
 - Normal or BOOST mode
 - Insect/Rodent selector switch to target pest problem
 - Red front LED indicates unit is powered
 - Red LED on back indicates unit ON
 - Audible TEST button
 - Frequency range 5-47 KHz
 - Can be wall mounted
 - 2 year manufacturer's warranty

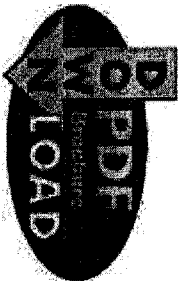

Buy this product directly from Amazon.com!
Purchase anything else from within their store and
save on shipping costs! Click on the product icon-->



[E-mail A Friend](#)

[Send the Webmaster your comments!](#)

© 2001 Lentek International, Inc.
Orlando, FL - (888) 3LENTEK
[Privacy Policy](#)

This Site Best Viewed With:



Indoor Pest Control Products

PC01 - PestContro Original - \$44.99

- [Pest Control](#)
- [Blagiante](#)
- [Pet Products](#)
- [Air Purification](#)
- [Comfort Air Cushions](#)
- [Personal Care](#)
- [Flashlights](#)
- [More...](#)

Pre-Releases
Our Best Sellers
Today's Web Specials
Outlet Center

- [Home Support](#)
- [Site features](#)

- ★ [Lentek Home](#)
- ★ [About Lentek](#)
- ★ [News & Events](#)
- ★ [Press Releases](#)
- ★ [Become A Lentek Dealer](#)
- ★ [Contacts at Lentek](#)
- ★ [Jobs @ Lentek](#)
- ★ [Search](#)

[REGISTER](#)

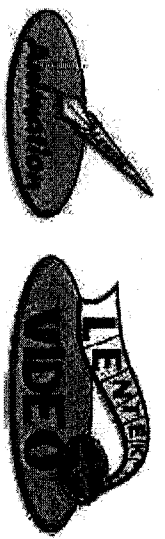
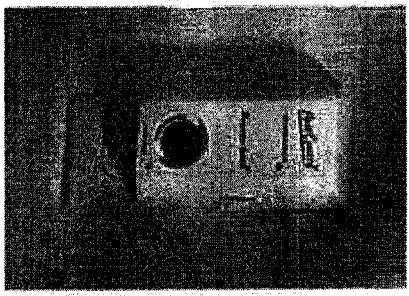

Lentek's Original PestContro is award-winning and our best seller. Plug into a AC outlet and our **MagnetoSonic technology** goes to work. This technology works within the walls and wiring of your home creating a very unfriendly place for pests. **Sweeping Sound Ultrasonic Technology** works within the living areas of the home creating a constant change in the audio frequency preventing the pest from becoming accustomed to the sounds.

Designed to repel: **ants, mice, rats, cockroaches, squirrels, bats, fleas, crickets, spiders, bees and waterbugs.**
Effective coverage 2500 sq. ft.



Uses MagnetoSonic Technology
Winner of the Smithfield Innovation Award
Tested and Approved by the National Home and Gardening Club
Over 1,000,000 units sold
UL and CE Approved
Two year warranty

The Original PestContro transmits an ultrasonic sound using "**Sweep Sound Technology**" that fluctuates patterns of sound unheard by humans and pets, but extremely irritating to pests. (Equipped with an optional switch to disable ultrasonic waves which may disturb hamsters or gerbils.)

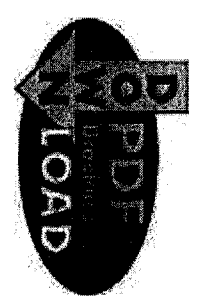

[E-mail A Friend](#)



[Send the Webmaster your comments!](#)

© 2001 Lentek International, Inc.
Orlando, FL - (888) 3LENTTEK
[Privacy Policy](#)

This Site Best Viewed With:
 IE 5+
 NN 6+



GO SHOPPING

Insectables

By Lentek

SEARCH:

Wednesday, October 10, 2001

Indoor Pest Control Products

PC02G- PestContro Deluxe - \$59.99

- Pest Control
- Biagiante
- Pet Products
- Air Purification
- Comfort Air Cushions
- Personal Care
- Flashlights
- More...

Pre-Releases
Our Best Sellers
Today's Web Specials
Outlet Center

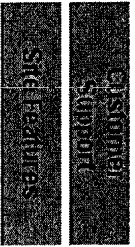

- ★ Lentek Home
- ★ About Lentek
- ★ News & Events
- ★ Press Releases
- ★ Become A Lentek Dealer
- ★ Contacts at Lentek
- ★ Jobs @ Lentek
- ★ Search

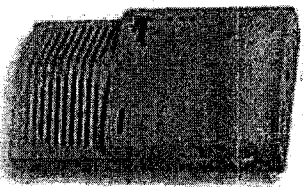

The new PestContro Deluxe allows you to make adjustments to suit your home's specific needs.

Effectively chases away rats, mice, squirrels, ants, fleas, roaches, waterbugs, and other household pests. Only one unit needed per household (coverage approximately 5,000 sq. ft.)

This plug-in unit uses Lentek's exclusive **MagnetoSonic Technology**. Features an audible test button, night light, three LED status indicators UL and CE approved Two year warranty Size 4 1/4"Hx 7 1/2"Lx 3 1/4"W. 6.8 oz.

Adjustable dual, ultrasonic frequency transducers transmit in stereo to maximize the coverage area in the room that the unit is in. This technology is used to alter the normal electrical field around wiring in your home's walls to chase pests from areas you can't access.



 [Back](#)

[E-mail A Friend](#)

- [Product Manuals](#)
- [Testimonials](#)
- [Home](#)
- [GOV](#)
- [Add to cart](#)
- [Check out](#)

[Send the Webmaster your comments!](#)

© 2001 Lentek International, Inc.
Orlando, FL - (888) 3LENTTEK
[Privacy Policy](#)

This Site Best Viewed With:





TRY BARKFREE TODAY!!!

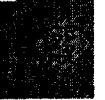

GO SHOPPING

SEARCH:



Wednesday, October 10, 2001

Pet Products

- Pest Control
- Biagiante
- Pet Products
- Air Purification
- Comfort Air Cushions
- Personal Care
- Flashlights
- More...

FC10- FleaContro 1000 - \$19.99

Add to cart



Pre-Releases
Our Best Sellers
Today's Web Specials
Outlet Center

- Customer Support
- Site Features

- ★ Lentek Home
- ★ About Lentek
- ★ News & Events
- ★ Press Releases
- ★ Become A Lentek Dealer
- ★ Contacts at Lentek
- ★ Jobs @ Lentek
- ★ Search

REGISTER

Help control your flea problem within a single room. Using **Ultra-Sonic Technology™**, this unique pest repeller is aimed specifically at fleas. Unit blasts harsh, ultrasonic siren (inaudible to humans) which helps repel fleas and control them within the area. Great for use in: homes, kennels, dens, basements, garages, offices, dorms, anywhere.

Covers up to 1000 square feet
UL and CE approved
Two year warranty





Use in areas with the greatest flea problem or a location where pets tend to frequent.
Simply plug into unobstructed wall outlet.

Will not affect pets and appliances:
The ultrasonic waves may affect rodent pets such as hamsters, gerbils and rabbits.
Position the unit in areas away from rodent pet and it may not cause discomfort for the pet.

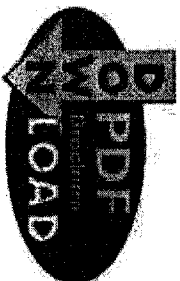

[E-mail A Friend](#)



[Send the Webmaster your comments!](#)

© 2001 Lentek International, Inc.
Orlando, FL - (888) 3LENTTEK
[Privacy Policy](#)

This Site Best Viewed With:





TRY BARKFREE TODAY!!!



GO SHOPPING

SEARCH:

GO

Wednesday, October 10, 2001

Indoor Pest Control Products

PR10- PestContro Ultrasonics 1000 - \$19.99

Add to Cart

- Pest Control
- Blagante
- Pet Products
- Air Purification
- Comfort Air Cushions
- Personal Care
- Flashlights
- More...

Pre-Releases
Our Best Sellers
Today's Web Specials
Outlet Center

- Customer Support
- Site Features

- ★ Lentek Home
- ★ About Lentek
- ★ News & Events
- ★ Press Releases
- ★ Become A Lentek Dealer
- ★ Contacts at Lentek
- ★ Jobs @ Lentek
- ★ Search

REGISTER

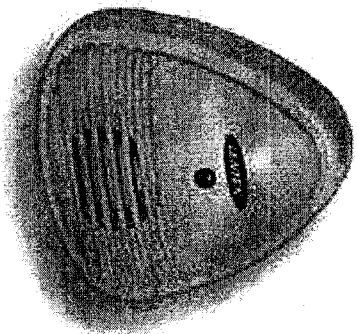

Lentek's new PestContro Ultrasonics 1000 is our latest ultrasonic powered pest repeller using advanced technology to miniaturize the size. Discreet design that looks like an air freshener.

Designed for rats, mice, ants, crickets, squirrels, bees, bats, waterbugs, spiders, and fleas.

Sound output will cover up to 1,000 square feet
Great for combining with any of the MagnetoSonic devices PestContro Original, PestContro Deluxe, PestContro 1000 which use our MagnetoSonic Technology for added ultrasonic protection in a problem area.

Use for: homes, basements, attics, sheds, garages, carports, dens, kennels, offices, RVs, apartments, dorms, restaurants.

110 dB output ultrasonic
Frequency range: 20Khz-85Khz
Unit measures only 3"x 2.9"x 1.1"
UL and CE approved
Two year warranty

Place one in each room for added protection

Exhibit O

Lentek's PestContro Ultrasonics 1000 and 2000 use the latest in sound technology to generate an amazing 110 dB and 120 dB. Because sound has its limitations as it cannot travel through walls or doors, for the best protection Lentek recommends that you add these products to a PestContro Original, PestContro Deluxe, or PestContro 1000, which use our MagnetoSonic Technology. Many customers buy multiple units to place throughout the home as added protection.

Great for added protection in any area in your home including:

- Garage
- Attic
- Basement
- Covered porch
- Any pest problem area

Sound output will cover up to 1,000 square feet; however, doors and walls need to be left open. The high generating sound is the most effective means to control a pest problem with a living area.

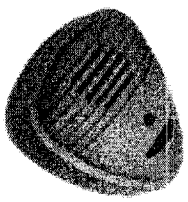
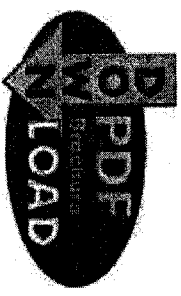

Buy this product directly from Amazon.com! Purchase anything else from within their store and save on shipping costs! Click on the product icon-->



[E-mail A Friend](#)



[Send the Webmaster your comments!](#)

© 2001 Lentek International, Inc.
Orlando, FL - (888) 3LENT EK
[Privacy Policy](#)

This Site Best Viewed With:





Pest Repelling Products

CHEMICAL FREE • ENVIRONMENTALLY SAFE

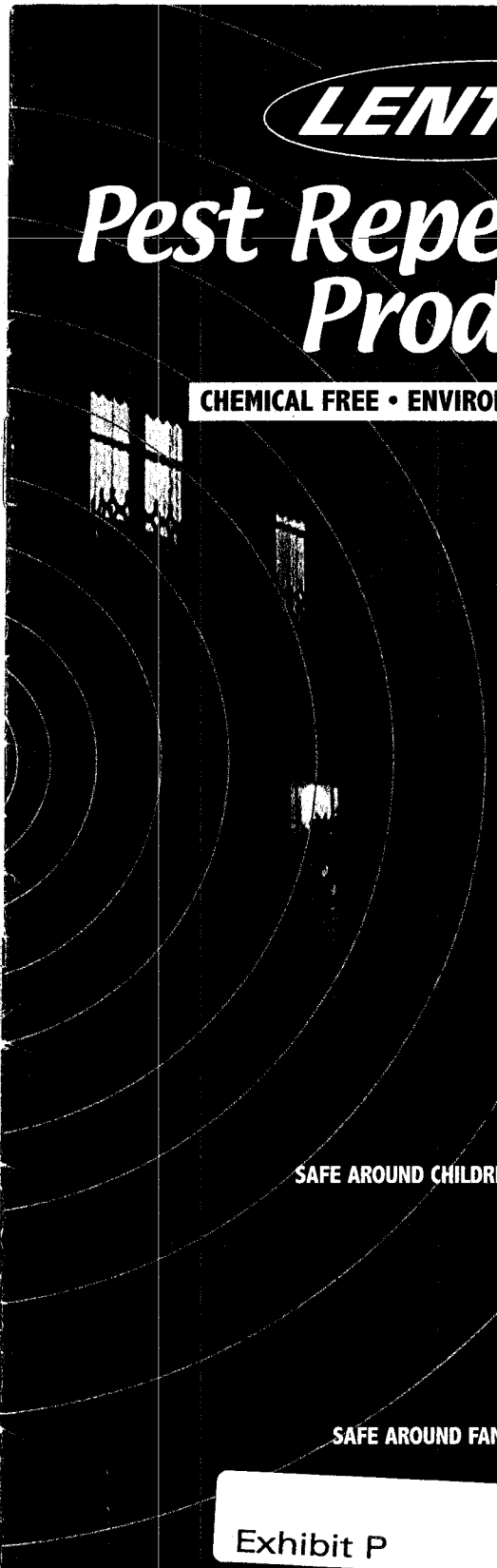

SAFE AROUND CHILDREN & FOOD

SAFE AROUND FAMILY PETS

Exhibit P



A World Leader in Electronic Pest Control Technology™

GREETINGS

Dear Customer,

Thank you for your interest in Lentek. We are proud to be a world leader in electronic pest control technology. Lentek has developed an entire line of environmentally safe pest control products to provide chemical free protection against pests including mice, rats, roaches, spiders, crickets as well as many more.

Lentek's development team, consisting of over twenty-five highly trained engineers, have perfected the effectiveness of these unique products. In addition, Lentek is pleased to exceed the international recognized quality standards, ISO 9001, in the production of all our products, while striving to be ahead of the competition by meeting quality and development standards unmatched throughout the industry.

After receiving tremendous success both nationally and internationally with The Original PestContro, Lentek has developed over thirty-eight additional models. As you will see inside this brochure, these pest control products include items for indoor and outdoor use as well as mosquito control. Unique security and pet products have also been developed to assist with security and pet needs. Each is developed to provide you, the consumer, with an effective product that will help resolve your pest problems.

We invite you to peruse our catalog and are eager to assist your needs. For more information on Lentek and any of our products please visit our website at: www.lentek.com. While online register to receive our free monthly newsletter!

Questions can be e-mailed directly to Lentek at: customerservice@lentek.com or you may call: 1-888-353-6835, or 407-857-8786. We thank you for your interest again.

Cordially,

Lou Lentine

Lou Lentine
President

Lentek has also developed a line of Air Deodorizer/Purifiers, called Sila™.

Learn more online at:
www.lentek.com
or call 888-3-LENTEK

LENTEK
Creating Solutions
for a Healthier Environment.



... A WORLD LEADER IN PEST CONTROL TECHNOLOGY

PESTCONTRO'S UNIQUE SYSTEM:

PestContro® utilizes Lentek's patented **Magneto-Sonic™ Technology**. This combines Electro-Magnetic Interference and Ultrasonic Sound Waves. By plugging a PestContro® device into any electrical outlet, the **Electro-Magnetic Interference** (appears in red in illustration below) alters the normal field around the existing wiring already within the walls. This effects the central nervous system of the pests that dwell there and drives them out.

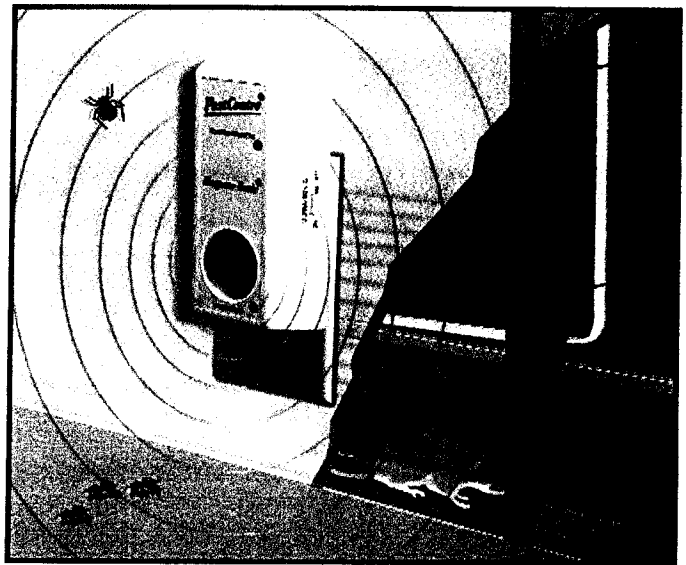

The **Ultrasonic Sound** feature (appears in green in illustration above), using Lentek's exclusive "Sweep Sound Technology" (SST), blasts a constantly changing sound pattern that causes auditory stress to any pests within the living area.

There is no opportunity for these pests to get comfortable enough to nest in your home. They just don't stand a chance against the one-two punch that only Lentek's PestContro® can deliver!

By understanding and utilizing this technology and how it effects animals, insects and other pests, and with the growing awareness of the environmental impact of pesticides and insecticides, Lentek has been able to incorporate variations of this very technology to develop several electronic and battery operated models for indoor and outdoor use. They offer an effective, **environmentally safe alternative to pesticides**. Lentek has also applied this technology to several pet products such as the innovative bark control system, BarkFree™, the worry free electronic guard dog, Spike™ and the Sila™ Waterless Bath Brush with Flea Repel. Lentek products come with a **Two (2) Year Limited Warranty** unless otherwise indicated, and/or are approved by **ETL, EPA, UL and CE**.

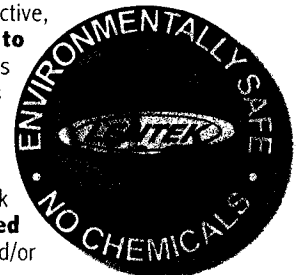

PC01 — USES *Magneto-Sonic™* —

- "Original" PestContro®** —
- Covers up to **2500 sq.ft.** (232 sq.m.) with Electro-Magnetic Interference within the walls of the home.
 - Ultrasonic Sound protects the living area.
 - Direct plug-in to any electrical AC outlet.



Official Winner of the "National Home Gardening Club" Award.



PC02 — USES *Magneto-Sonic™* —

- PestContro® Deluxe** —
- Covers up to **5000 sq.ft.** (465 sq.m.) with Electro-Magnetic Interference within the walls of the home.
 - Dual Ultrasonic Sound advanced speakers.
 - Adjustable Ultrasonic Sound settings that target the pest problem within the living area.
 - Direct plug-in to any electrical AC outlet.
 - Test button for pest setting confirmation.
 - Built-in night light.

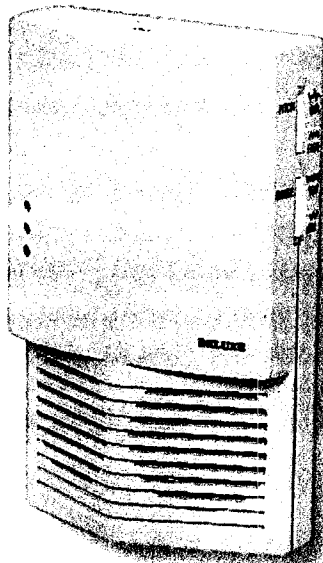

SPECIALTY ITEM

- AP10 **Add-A-Plug™** —
No more wasted outlets!

NEW!

IDEAL FOR DIRECT PLUG-IN DEVICES

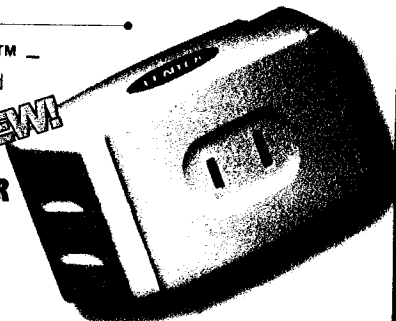

PC04 — USES *Magneto-Sonic™* —

- PestContro® 1000** —
- Same technology as "The Original PestContro" but designed for smaller areas.
 - Covers up to **1000 sq.ft.** (93 sq.m.) with Electro-Magnetic Interference within the walls of the home.
 - Ultrasonic Sound protects the living area.
 - Direct plug-in to any electrical AC outlet.

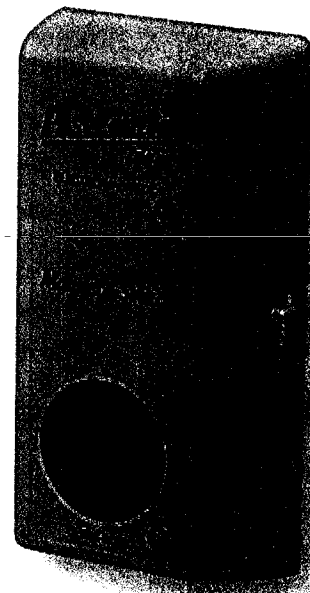

PestContro® ULTRASONICS™

- Ultra-Sonic Sound protects the living area.
- Compact miniaturized design.
- Will not interfere with additional outlet usage.
- **Great for combining with Lentek products with *Magneto-Sonic™* Technology.**
- Direct plug-in to any electrical AC outlet.

- PR10 **PestContro® ULTRASONICS™ 1000** —
- Covers up to **1000 sq.ft.** (93 sq.m.).

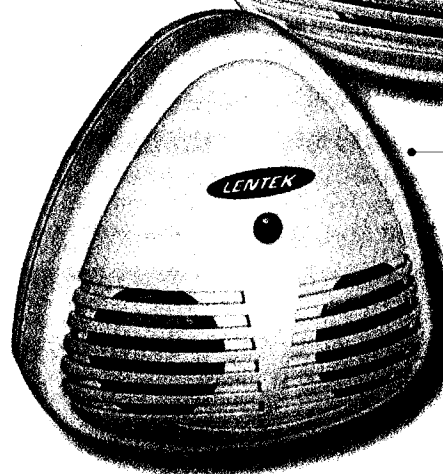
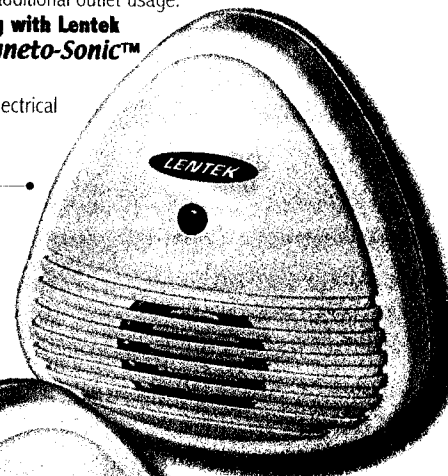

- PR20 **PestContro® ULTRASONICS™ 2000** —
- Covers up to **2000 sq.ft.** (186 sq.m.).

INDOOR REPELLERS (CONTINUED)

OUTDOOR REPELLERS

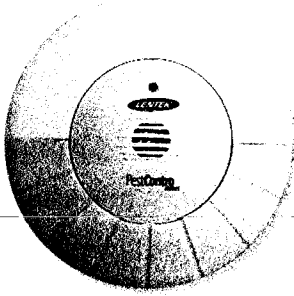

- PC09 PestContro® Closet –**
- Moth or insect repel setting.
 - Perfect for closets and small rooms.
 - **Closet light** with auto shut-off.
 - Uses one (1) 9 volt and two (2) AA batteries.
 - AC adapter plug (adapter sold separately)

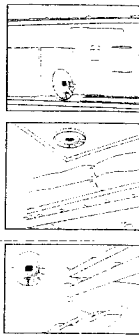

FOR INDOOR & OUTDOOR USE

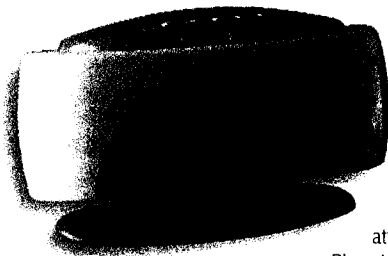

- NEW!**
- SP10 Select-A-Pest™ –**
- Allows user to target their particular pest problem with the push of a button.
 - Covers up to **7500 sq.ft.** (697sq.m)
 - Ideal for large open areas such as attics, basements, and warehouses.
 - Plugs in to any electrical AC outlet.

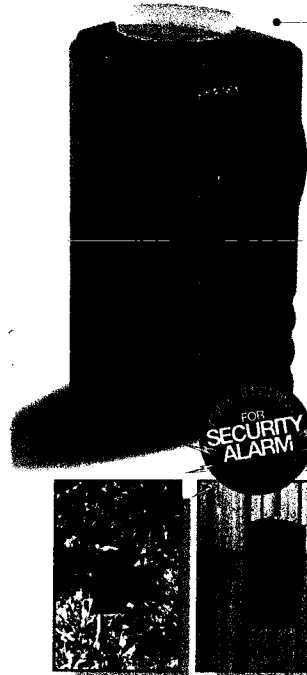

**YardContro+™ –
RADAR SENSOR SYSTEM**

- Repels most animals, including deer, raccoons, skunks, squirrels, rabbits, dogs, cats, rats, using a slide ultrasonic switch. (20kHz - 50kHz).
- Audible security setting to deter human intruders.
- Features **360°** motion activated sensor. Will detect motion within a **30 ft.** (9.1m) area.
- Acoustically designed transducer system that emits a loud 120 decibel ultrasonic sound blast.
- Low battery consumption; lasts at least 10,000 sound releases.
- Weatherproof design allows for outdoor use.
- Built-in test mode button.
- LED function indicator light.
- Bracket for wall, tree or post mounting.
- Battery operated (4 'D' batteries).
- AC adapter plug (adapter sold separately).



RC77

XContro™ – RADAR SENSOR SYSTEM

- Keeps most insect pests, mice, cats, squirrels, skunks, raccoons and other rodents away using a slide ultrasonic switch (20kHz - 85kHz).
- Features **360°** motion activated sensor. Will detect motion within a **30 ft.** (9.1m) area.
- Acoustically designed transducer system that emits a loud 120 decibel ultrasonic sound blast.
- Low battery consumption; lasts at least 10,000 sound releases in sweep setting.
- Setting for "continuous" sound bursts.
- Weatherproof design allows for outdoor use.
- Built-in test mode button.
- LED function indicator light.
- Bracket for wall, tree or post mounting.
- AC adapter plug included.
- Can be battery operated - 4 'D' batteries (not included).

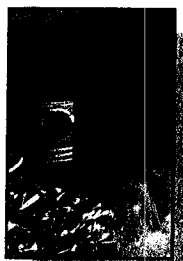

PC03

PestContro® Outdoor –

- Prevents unwanted animals from entering the designated area.
- Covers a **1250 sq.ft.** (116 sq.m) area.
- Uses adjustable Ultrasonic Technology.
- Weatherproof design with rain cover for additional protection for outdoor use.
- Numerous adjustable settings to target animals, including "CAT SAFE" settings.
- Built-in test mode button.
- 3 LED function indicator lights.
- Includes mounting attachment and 50 ft. (15m) outdoor extension power cord.

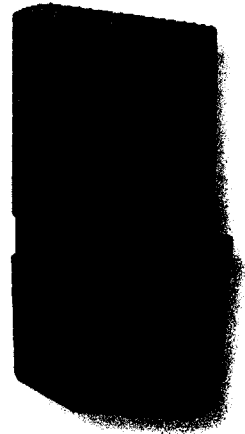

PC8L

MoleContro™ Deluxe –

- Inserts into ground to keep burrowing animals out of the area.
- Frequency Selector Switch allows user to target specific breeds of burrowing animals.
- Covers a **9000 sq.ft.** (836 sq.m) area.
- Uses 2 "D" batteries that last 4-6 months.
- Aluminum waterproof design.
- **10 year warranty.**

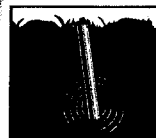

PC8P

MoleContro™ –

- Inserts into ground to keep burrowing animals out of the area.
- Covers a **7500 sq.ft.** (697 sq.m) area.
- Uses 2 "D" batteries that last 4-6 months.
- Plastic waterproof design.
- **2 year warranty.**



BIRD REPELLERS

FLYING INSECT TRAPS

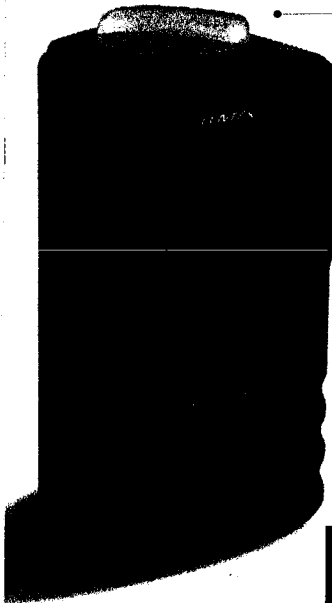

BC15

BirdContro™ – RADAR SENSOR SYSTEM

- Repels birds by outputting random digitized bird distress calls or a gunshot noise.
- Features **360°** motion activated sensor. Will detect motion within a **30 ft.** (9.1m) area.
- Adjustable settings to repel birds within a small garden or up to an acre of property—
- Low battery consumption; lasts at least 2000 sound releases.
- Weatherproof design allows for outdoor use.
- Built-in test mode button.
- LED function indicator light.
- Bracket for wall, tree or post mounting.
- Battery operated (4 'D' batteries).
- AC adapter plug (adapter sold separately).

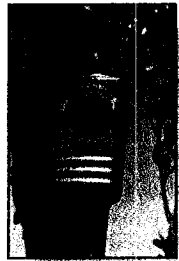

Two Different Detering Sounds!



BB01

Bye-Bye Birdie-Wing –

- Keeps flying birds away from designated "Bird-free" area.
- Specialized patented Magnetic System.
- Covers up to a **15 - 20 ft.** (4.5 - 6m) designated area.
- Easy to install - No electric/batteries.

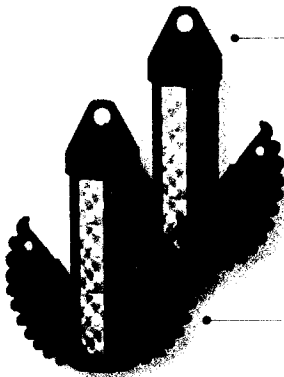

BB02

Bye-Bye Birdie-Power Wing –

- Covers up to a **70 ft.** (21m) designated area.

FLYING INSECT TRAPS

E-TRAP™ – THE ELECTRONIC FLYING INSECT TRAP

NEW!

E-TRAP IS NOT A BUG ZAPPER!

Dangers found with "Bug Zappers" and Glue Traps:

Research has been published recently on how "Bug Zappers" explode the flying insect when it comes in contact with their electrical grids. This explosion results in sending micro-organisms, such as bacteria, viruses and insect particles, as far as six feet away. Glue Traps also don't eliminate these viruses. In fact, they gather all the bacteria into one place, exposing you and your family to all sorts of contaminants.

How the E-trap differs from a "Bug Zapper":

Similar to a "Bug Zapper", the high density ultraviolet lights attract flying insects to the trap. *But...here's how the E-trap differs from a "Bug Zapper."* As the insect nears the reflective grid located at the rear of the cabinet, using patent pending technology, it experiences a continuous low voltage shock that temporarily disables the insect. It then drops downward to the exclusive sound suppression chamber. Inside the chamber, where another, slightly different, low voltage grid slowly disables and dehydrates the insect. You then simply remove the sound suppression chamber drawer and discard the "dried" insects into the trash.

There's no exposure to the bacteria, no exploding insect parts, no burning electrical smells, no popping noises... and no flying insects to bother you.

The E-trap has manual settings for day and night, but the FT15 and FT25 also have a built-in sensor that automatically switches from day to evening, as most of us would experience more mosquitoes during the night and flies during the day.

☾ Nighttime Setting –

This sets the voltage charge that stuns the insect specifically aimed at mosquitoes and other evening flying insects.

☀ Daytime Setting –

This sets the voltage charge that stuns the insect specifically aimed at flies and other daytime flying insects.

AUTO Automatic Setting –

Sensor automatically switches from day to evening setting.

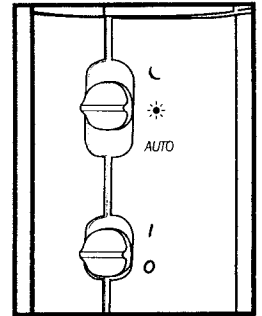

FT25
E-Trap Industrial

FT15
E-Trap Home/Business

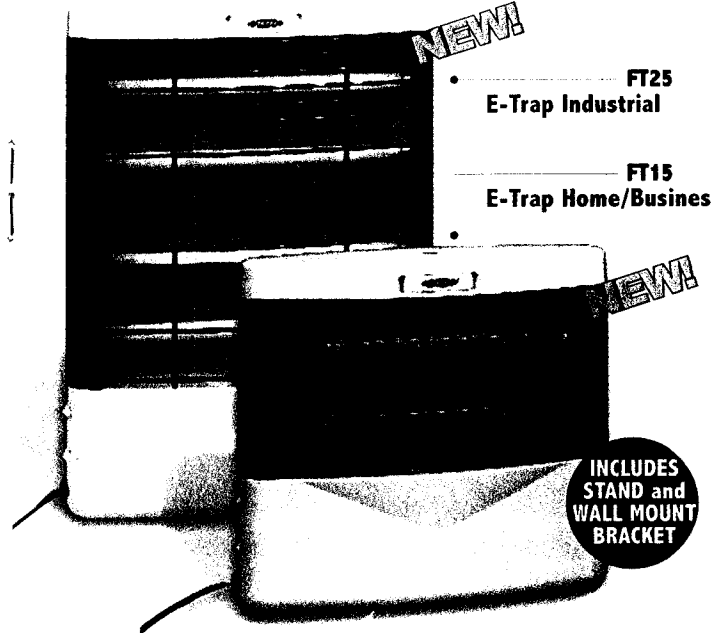

INCLUDES
STAND and
WALL MOUNT
BRACKET

MOSQUITO REPELLERS

MosquitoContro™ emits a frequency that matches the wing speed (noise) of a male mosquito. Female mosquitoes instinctively steer clear of male mosquitoes, and since female mosquitoes are the only ones that bite humans, by replicating this sound the female mosquito is repelled from biting within the area.

**CHEMICAL FREE – SAFE FOR KIDS!
FOR INDOOR & OUTDOOR USE**

**No More
Messy Lotions
or Sprays!**

MC03 MosquitoContro™ Card – **NEW!**

- Two Adjustable frequencies:
 - 1 Male Mosquito setting
 - 1 Dragonfly setting
- Covers an area of personal space.
- Perfect for any outdoor activity, including golfing, hiking, biking, skating and fishing.
- Key chain attachment.
- Clips on to belt or pocket.
- Uses one (1) button cell battery (included).



MC04 MosquitoContro™ Portable – **NEW!**

- Three Adjustable frequencies:
 - 2 Male Mosquito settings
 - 1 Dragonfly setting
- Tabletop design for portability.
- Covers 256 sq.ft. (24 sq.m.).
- Perfect for indoors or picnics and other outdoor activities.
- Amber night light.
- Uses two (2) 'C' batteries (not included).

MC05 MosquitoContro™ Plus – **NEW!**

- Two Adjustable frequencies:
 - 1 Male Mosquito setting
 - 1 Dragonfly setting
- Red flashlight for night time assistance.
- Includes **NEW & IMPROVED** Velcro® wrist and/or ankle strap.



- Built-in pocket/belt clip
- Small lightweight design.
- Uses one (1) button cell battery (included).

MOSQUITO DESTROYERS

The Tomb™ destroys mosquitoes by electro-chemical evaporation. The active ingredients in the Tomb Mat evaporated by the Tomb Heaters are invisible and non-irritating to humans, but deadly to mosquitoes. The special temperature-controlling semi-conductor used in the Tomb units assures safe and stable operation with continuous peak efficiency.



NEW!

- SAFE** - Non-irritating to throat and eyes. Safe around children and pets. Never overheats.
- AROMATIC** - Emits a pleasing fragrance while operating.
- ECONOMICAL** - Each Tomb Mat lasts twelve full hours; electricity used is negligible.
- EASY TO USE** - Just place a Tomb Mat in the unit and plug into any electrical outlet.
- CLEAN** - Smokeless; does not burn to ash; will not soil walls or furnishings.
- FAST RESULTS** - Tomb starts to work the moment it's plugged in.

MM10 Tomb™ Tabletop – **NEW!**

- Protects up to a 15 ft. (4.5m) diameter.
- Includes 6 mats - Each mat lasts 10 hours.
- Retractable cord plugs into any 110 volt AC outlet.
- Wall mountable.
- Includes Bonus oil fragrance chamber for aromatherapy.

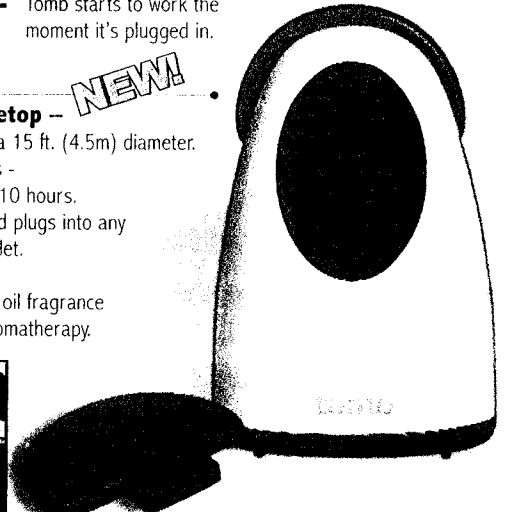
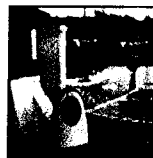

MM10 Tomb™ Plug-In – **NEW!**

- Protects an area of up to 12 x 12 ft. (3.7 x 3.7m).
- Includes 6 mats - Each mat lasts 10 hours.
- Direct plug-in design plugs into any 110 volt AC outlet.
- Includes Bonus oil fragrance chamber for aromatherapy.

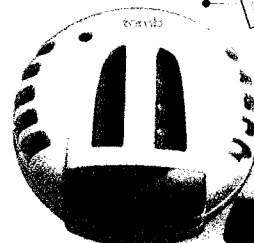

MM10 Tomb™ Mat Refills – **NEW!**

- Each box includes 30 mats.
- Each mat lasts 10 hours.
- Mat turns white when the active ingredients have been exhausted.
- Each mat is individually wrapped.



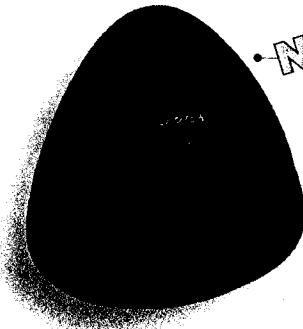

NEW!

FC10 FleaContro™ ULTRASONIC –

- Ultrasonic Sound frequency targeted specifically to deter fleas from the living area.
- Compact miniaturized design.
- Will not interfere with additional outlet usage.
- Direct plug-in to any electrical AC outlet.
- Covers up to **1000 sq.ft.** (93 sq.m.).

PC06 Bark Free™ –

- Keeps dogs from barking using humane Ultrasonic Sound.
- Perfect to help control your or your neighbor's barking dog.



- Weatherproof design with rain cover for additional protection for outdoor use.
- Covers **1250 sq.ft.** (116 sq.m.).
- AC adapter with a 50 ft. (15m) extension power cord.

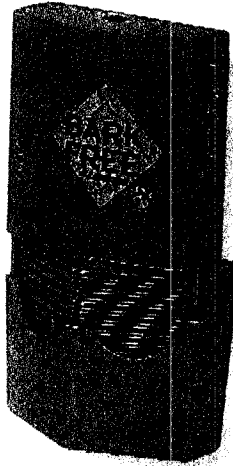

PP10 Pet Chime™ –

NEW!

- Portable wireless electronic pet doorbell allows your dog to tell you when he needs to go out.
- FCC approved radio frequency.
- Remote control, designed to look like paw print, works up to **100 ft.** (30.5m) away from the chime.
- Chime can be mounted on wall or stand on a table or shelf.

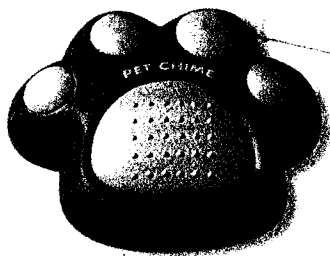
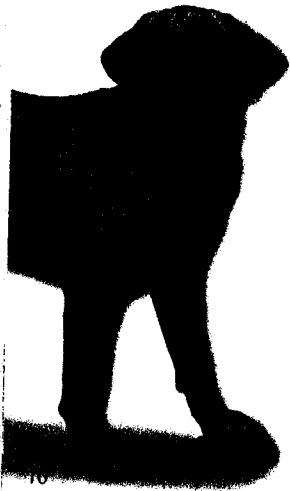

- Choice of two different tones: (1) Ding Dong Chime (2) Dog Bark
- Battery operated: Remote paw: (1) 9 volt battery Chime: (3) 'AA' batteries (Batteries not included)

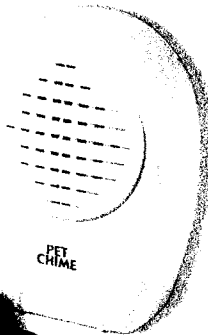

10-50

Sila™ Waterless Bath & Flea Repel Brush –

- Neutralize pet odors while repelling fleas every time you brush your pet.
- Sturdy bristles help comb out stubborn tangles.
- Silently bathes your pet with up to 100 trillion super oxygenated molecules every second.
- Exclusive Lentek flea repelling technology.
- Auto shut-off after 5 minutes.
- Runs on one 9 volt battery.
- Push button on/off switch.
- Handle slot for hang storage.
- One (1) year warranty.

NEW!

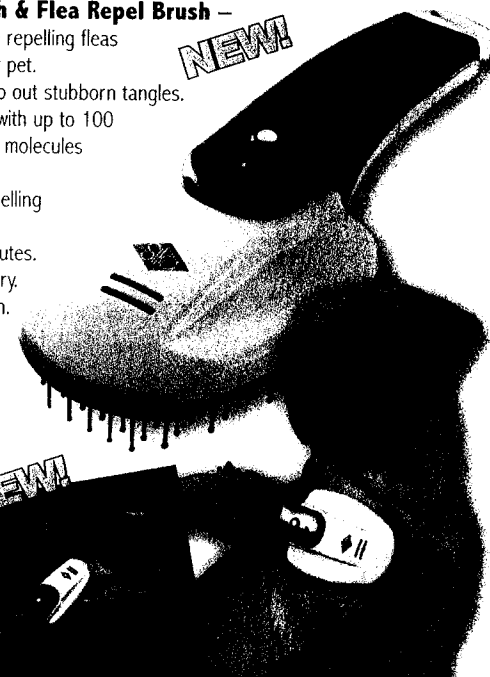

ALSO AVAILABLE:

10-55

Sila™ Waterless Bath Brush –

- Same as 10-55, only smaller and without flea repel technology. **Ideal for smaller pets.**

NEW!

INNOVATIVE SECURITY

Spike™ – RADAR SENSOR SYSTEM

Spike, Lentek's Radar Sensing Electronic Guard Dog, protects your home, office or car 24 hours a day. It senses motion through walls, doors, glass and even bricks, in all directions. When it senses motion it responds with your choice of four (4) intimidating alarm sounds. The digitized guard dog alarm barks like an attack dog, realistically changing to fierce and snarling sounds as the intruder comes closer. For an even more intimidating response, select the sound of multiple guard dogs.

Plus you can switch to the ear piercing burglar alarm and repel trespassers with an oscillating siren.

TC78

FEATURES:

- 105-115 db acoustically designed speaker system.
- **360°** motion sensor detection.
- Adjusts to detect motion up to **15 ft.** (4.6m) from the unit.
- Radar senses through objects up to 4" thick.
- Adjustable volume.
- Weatherproof design allows for outdoor operation.
- Wall mount, tree mount or post mount.
- Battery operated with DC adapter capability.

BENEFITS:

- Protects home 24 hours a day.
- Four alarm settings to scare off intruders.
- Doesn't need water or food.
- Doesn't require walking or cleanup.



NOTE: If you have a pest not mentioned on the chart-
Contact your local Lentek Dealer or call: **888-3-LENTEK**

INDOOR UNIT IN/OUTDOOR UNIT

OUTDOOR UNIT

INDOOR UNIT

COMMON PESTS Lentek products are designed to affect:	INDOOR UNIT																	IN/OUTDOOR UNIT																	OUTDOOR UNIT																	Area Covered
	ANTS	ARMADILLOS	BATS	BEEES	BIRDS	CATS	OTHER CRAWLING INSECTS	CRICKETS	DEER	DOGS	FLEAS	FLIES	FLYING INSECTS	GOPHERS	GROUND SQUIRRELS	KANGAROO RATS	MICE	MOLES	MOSQUITOES	MOTHS	OPPOSSUMS	POCKET MICE	RABBITS	RACCOONS	RATS	ROACHES	SHREWS	SKUNKS	SPIDERS	SQUIRRELS	TICKS	WOODCHUCKS	WATERBUGS	HUMAN INTRUDERS																		
PC01-"Original" PestControl	●		●	●							●	●																								2500 sq.ft. (232 sq.m)																
PC02-PestControl Deluxe	●		●	●							●	●																							5000 sq.ft. (465 sq.m)																	
PC04-PestControl 1000	●		●	●							●	●																							1000 sq.ft. (93 sq.m)																	
PR10-Ultrasonics 1000	●		●	●							●	●																							1000 sq.ft. (93 sq.m)																	
PR20-Ultrasonics 2000	●		●	●							●	●																							2000 sq.ft. (186 sq.m)																	
SP10-Select-A-Pest	●		●	●							●	●																							7500 sq.ft. (697 sq.m)																	
PC09-PestControl Closet																																			4 x 8 ft. (120 x 240 cm)																	
RC77-X-Contro	●		●	●							●	●																							30 ft. (9.1 m) radius																	
YC12-YardContro+	●		●	●							●	●																							30 ft. (9.1 m) radius																	
PC03-PestControl Outdoor	●		●	●							●	●																							1250 sq.ft. (116 sq.m)																	
PC8L-MoleControl Deluxe	●		●	●							●	●																							9000 sq.ft. (836 sq.m)																	
PC8P-MoleControl																																			7500 sq.ft. (697 sq.m)																	
BC15-BirdControl				●																															30 ft. (9.1 m) radius																	
BB01-Bye-Bye Birdie Wing				●																															15-20 ft. (4.5 - 6 m) radius																	
BB02-Bye-Bye Birdie Power Wing				●																															70 ft. (21 m) radius																	
FT15-E-trap Home/Bus.																																																				
FT25-E-Trap Industrial																																																				
MC03-MosquitoControl Card																																																				
MC04-MosquitoControl Portable																																																				
MC05-MosquitoControl Plus																																																				
MM10-Tomb Tabletop																																																				
MM20-Tomb Plug-in																																																				
FC10-FleaControl																																																				
PC06-Bark Free																																																				
PP10-PetChime																																																				
IO-50-Slia Pet Brush																																																				
TC78-Spike																																																				



LENTEK INTERNATIONAL, INC.

P.O. Box 593812
Orlando, FL 32859-3812

Phone: 407-857-8786

Fax: 407-857-4045

Toll Free: 800-456-3443

E-Mail: customerservice@lenteck.com

visit us on the web:
www.lenteck.com

PRESORT STD
US POSTAGE
PAID
PERMIT #2599
ORLANDO, FL

SUCCESS STORIES FROM AROUND THE WORLD

"We have had cluster-fly and lady-bug problems for 10 years. Two weeks ago, after we installed the PestControl Deluxe, the problem wasn't just decreased, as has been the case with a professional exterminator 4 times a year, it is **NON-EXISTENT!** In fact, we are in awe that it **REALLY DOES WORK!**"
C. Gaspero of Monsee, IL

"As a restaurant owner, I was having a pest control company come in every three weeks for service. Finally, six months ago we purchased a PestControl unit. Since then, there has been no sign of any pests of any kind. My husband suffers from acute chronic asthma, so every time we sprayed for pests he was unable to come into our restaurant for at least 24 hours afterwards. But now I have to put up with him all the time! I am so pleased with the PestControl unit that I have put additional units in our home and farm."
J.K. O'Patik of Wayland, Michigan

"... We live in a cottage built after 1600 with walls about 25 inches thick, and we had ant nests in the walls! Your device, after a short period of time, has solved a major problem in a very old house.
I am very grateful!"
E.W.T. Dicken, England

AD00165
LITLEN1-0100

© 1999 Lenteck International, Inc. All rights reserved.
All specifications are subject to change without notice.



Effective, Chemical-free Pest Solutions.

GO SHOPPING

SEARCH: GO

Tuesday, March

- Products
- PestContro
- Home Fragrance
- Security
- Pet Products
- Sila Air Purifiers
- Accessories
- Pre-Releases
- Top 10 Products
- Web Only Specials
- Show All Products

8³⁰am-5³⁰pm EST



Monday-Friday

Customer Support

Company Information

- Lentek Home
- About Lentek
- News & Events
- Press Releases
- Become A Lentek Dealer
- Contacts at Lentek
- Jobs @ Lentek

Site Features

- Subscribe!
- Tell A Friend
- E-Letter Archive
- Post Your Pet Pictures!
- Site Map
- Premier Partners
- Lentek Links
- Be A New Product Tester
- Submit New Product Ideas
- For The Trade
- Lentek Gopher Bash



Press Release

Release Date: Immediate

Released By: Lentek International
Contact Person: Kam Prince kprince@lentek.com
Contact Phone Number: (407) 857-8786
Contact Fax Number: (407) 857-4045

Mosquito Relief - Without Chemicals

(Orlando, FL) July 26, 2000 - The recent detection of the lethal West Nile virus in New York City and Boston has prompted city officials to begin spraying pesticide to kill the mosquitoes. This has angered some because of the problems insecticides may impose on humans' endocrine and immune systems. City health officials also warned that pesticides might affect asthmatics and those with allergies as well.

Consumers no longer have to risk their health and the environment with toxic chemicals. Lentek International, a leader in the chemical free pest control industry, offers a product that repels mosquitoes without the use of hazardous chemical sprays or lotions. MosquitoContro Plus™ ingeniously combines the laws of nature and technology.

Using the most advanced Ultra-Sound technology, MosquitoContro Plus™ replicate sounds known in nature to repel the female mosquitoes, the only sex that bites humans. One sound replicates the wing speed frequency of the dragonfly, the mosquito's natural predator. The other sound replicates the wing speed frequency of the aggressive male mosquito. This combined technology works great to keep the biting female mosquito away.

With mosquitoes biting 24 hours a day, protection from these pests is necessary whenever you go. MosquitoContro Plus™ includes a built in strap to wear on the wrist or ankle as well as a "tag-on-clip" to attach to a belt or pocket. MosquitoContro Plus™ provides a chemical free alternative to help repel them.

Lentek International offers a warranty on MosquitoContro Plus™ and each unit carries a 60-day money back guarantee. MosquitoContro™ Plus has a manufacturer's suggested retail price of \$19.95. Customers can order directly from Lentek by calling toll-free 888-3LENTEK (888-353-6835). Ordering directly from Lentek includes free shipping and handling. For further product information, visit their website at www.lentek.com or email info@lentek.com. For further information contact Kam Prince at (407) 857-8786.

###

[[Go Shopping](#) | [Customer Support](#) | [Site Map](#) | [F.A.Q.](#) | [Questions & Support](#)]

Send the Webmaster your comments!

© 2001 Lentek International, Inc.
Orlando, FL - (888) 3LENTEK
[Privacy Policy](#)



This Site Best Viewed With IE 5+

Exhibit Q





Bite Shield by Lentek



GO SHOPPING

SEARCH:

Thursday, October 11, 2001

- Pest Control
- Blagiartha At Home
- Pet Products
- Air Purification
- Comfort Air Cushions
- Personal Care
- Flashlights
- More...

Pre-Releases
Our Best Sellers
Today's Web Specials
Outlet Center

- Customer Support
- Site Features

- ★ [Lentek Home](#)
- ★ [About Lentek](#)
- ★ [News & Events](#)
- ★ [Press Releases](#)
- ★ [Become A Lentek Dealer](#)
- ★ [Contacts @ Lentek](#)
- ★ [Jobs @ Lentek](#)
- ★ [Search](#)

REGISTER PRODUCTS

[FrontPage Include Component]
Press Release

Release Date: Immediate

Released By: Lentek International
Contact Person: Joe Durek jdurek@lentek.com
Contact Phone Number: (407) 857-8786
Contact Fax Number: (407) 857-4045

Bugged By Mosquitos?

There's MosquitoContro™ Plus, the World's First Electronic & Environmentally Safe Mosquito Repeller That You Can Wear Doesn't Use Hazardous Chemicals, Sprays or Lotions.

(Orlando, FL) This year start planning ahead for mosquito season by giving the kids or the outdoor adventurer in the family the environmentally safe and wearable MosquitoContro™ Plus from Lentek International. It uses Ultra Sound Technology to repel the biting female mosquito and best of all, you can wear it like a watch or attach it to a belt or pocket for easy pest repelling. Combining the laws of nature and technology, the MosquitoContro™ Plus replicates both the wing-beat frequency of the Dragonfly, the mosquito's most feared predator, and the wing-speed sound of the aggressive male mosquito, which the blood-thirsty female mosquito instinctively steers clear of after mating.

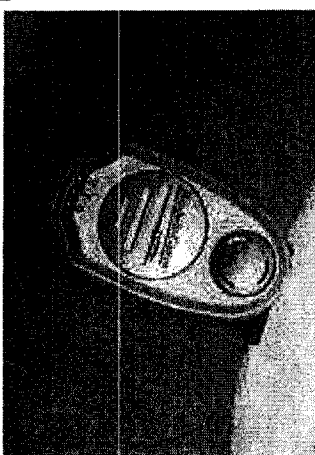

MosquitoContro™ Plus attaches easily to you or your clothing. There is a built-in strap so you can wear it on the wrist or ankles, as well as a "tag-on-clip" for attaching to a belt or pocket. Its compact, lightweight design makes it easy to wear on long hikes and weekend campouts. MosquitoContro™ Plus is battery operated, requiring only one standard button cell battery.

MosquitoContro™ Plus comes with the following features: • Small Compact Design • Built-In Strap for Wrist • Clip-On Attachment for Belts or Pockets • Easy On-Off Switch • Battery



Operated (standard button cell battery) • Color-Metallic Silver with Black Strap and Clip
• Compact Size (1/5" x 1" x 3/8")

MosquitoContro™ Plus has a manufacturer's suggested retail price of \$19.95. Customers can order directly from Lentek by calling toll-free 888-3LENTEK (888-353-6835). Ordering directly from Lentek includes free shipping and handling. For further product information, visit their website at www.lentek.com or email at info@lentek.com. or contact Lentek International, Inc.; PO Box 560445, Orlando, FL 32856-0455, telephone (407) 857-8786, fax (407) 857-4045.

###

Note to Editors: For product samples, contact Kelli Lentine (407) 240-3320

[Send the Webmaster your comments!](#)

This Site Best Viewed With:
Orlando, FL - (888) 3LENTEK
[Privacy Policy](#)



[FrontPage Include Component]



Tired of Fido barking all the time?



GO SHOPPING

SEARCH:

GO

Saturday,
March
03, 2001

Products

- PestContro
- Home Fragrance
- Security
- Pet Products
- Sila Air Purifiers
- Accessories
- Pre-Releases
- Top 10 Products
- Web Only Specials
- Show All Products

8³⁰ am-5³⁰ pm EST



Monday-Friday

Customer Support

Company Information

- Lentek Home
- About Lentek
- News & Events
- Press Releases
- Become A Lentek Dealer
- Contacts at Lentek
- Jobs @ Lentek

Site Features

- Subscribe!
- Tell A Friend
- E-Letter Archive
- Post Your Pet Pictures!
- Site Map
- Premier Partners
- Lentek Links
- Be A New Product Tester
- Submit New Product Ideas
- For The Trade
- Lentek Gopher Bash

**REGISTER
PRODUCTS**

News and Events

Pesticide Exposure Linked to Parkinson's Disease

Date: 11/14/00 - (Orlando, FL)-A recent study published in Nature Neuroscience indicates that exposure to a widely used gardening pesticide may cause the debilitating physical symptoms of Parkinson's, as well as killing brain cells. Parkinson's disease is characterized by tremors, muscle stiffness, impaired balance and is caused by the death of brain cells, which produce the neurotransmitter dopamine. More than one million Americans suffer from Parkinson's.

The pesticide, Rotenone, is an organic product made from extracts of tropical plants and is used as an agricultural pesticide and to kill unwanted fish in reservoirs. Ingestion of rotenone would come by way of residue in food or by handling. While the effects of rotenone seem to be representative of the possible effects of exposure to low amounts of other environmental toxins, new studies will rejuvenate the search for environmental toxins, including other pesticides that may contribute to Parkinson's disease.

Lentek International, a leader in the chemical free pest control industry, offers products that repel various household and garden pests without the use of hazardous pesticides. By not using pesticides, there is a lessened chance of ingesting any chemicals that could lead to Parkinson's or another deadly disease.

SOURCE: Nature Neuroscience November 2000

###

[[Go Shopping](#) | [Customer Support](#) | [Site Map](#) | [F.A.Q.](#) | [Questions & Support](#)]

[Send the Webmaster your comments!](#)

© 2000 Lentek International, Inc.
Orlando, FL - (888) 3LENTEK

[Privacy Policy](#)



[This Site Best Viewed With IE 5](#)



LENTEK

A World Leader in
Electronic Pest Control Technology™

ENVIRONMENTALLY SAFE™
LENTEK
NO CHEMICALS

mosquito **CONTRO**™

Repels mosquitoes from
your personal space.

NO
SPRAYS

NO
FUMES

NO
LOTIONS

NO
CHEMI-
CALS

NO
SMELLS

SAFE
FOR
KIDS!

BATTERY INCLUDED!

NON-
TOXIC

Will NOT affect:
cats, dogs, fish & birds.

MC05



MosquitoContro+ is an advanced technology insect repellent that makes outdoor living and activities more enjoyable from the annoyance of mosquitoes. It works to help protect you while you're fishing, camping, hiking, jogging, on the golf course, or just at ease on your patio or porch.

MosquitoContro+ is an environmentally friendly, electronic repeller that replicates the wing-beat frequency of the dragonfly, the foremost predator of the mosquitoes that bite. Taking advantage of the mosquitoes' natural avoidance of the dragonfly, the Mosquito Contro+ keeps them at a distance without odors, oils, creams or chemicals. In addition, in order to provide protection for various mosquito species (over 2,000), Mosquito Contro+ is the first electronic repellent that also mimics the wing beat frequency of a male mosquito. Female mosquitoes are the only ones that bite humans and animals, by replicating this sound, the MosquitoContro+ helps to repel the female mosquitoes within the area. The combination of both dragonfly and male mosquito frequencies makes **MosquitoContro+ the most effective electronic repellent available.**

- 24 hour protection.
- **DUAL TECHNOLOGY SELECTOR SWITCH** adapts to different mosquito species.
- Strap for wrist or ankle placement.
- Built in clip for easy attachment to:
 - Belts
 - Pockets
 - Bags
 - Backpacks
 - ...anywhere!
- Easy ON/OFF switch.

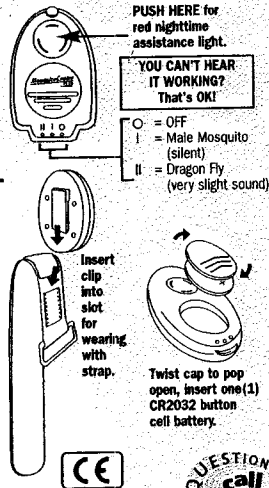

www.lentek.com



LENTEK INTERNATIONAL, INC.
PO Box 593812
Orlando, FL 32859-3812
Phone: 407-857-8786
FAX: 407-857-4045
E-Mail: customerservice@lentek.com

QUESTIONS? call 888-3-LENTEK

MADE IN CHINA
US EPA EST NO. 067644-CHN-001



4100-MC5A021202